



# XTR70020

## High Temperature, High Input Voltage 2A Positive LDO Regulator

Rev 3 – August 2021 (DS-00593-14)

### Data Sheet



PRODUCTION

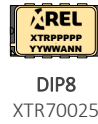

### FEATURES

- Operational beyond the -60°C to +230°C temperature range.
- Input voltages from 3.0V to 30V.
- Possible output voltages from 0.6V to 30V.
- Accurate bandgap reference (+/-3%).
- No minimum dropout imposed (current limited).
- High output current with low dropout:
- 1A @ 230°C with 0.63V, 2A @ 230°C with 1.4V
- Low current consumption in full-power (2.3mA) and low-power modes (950µA).
- Over current protection (hiccup mode).
- Customer selectable Thermal Shutdown protection.
- Customer selectable UVLO protection.
- Low noise : 550uV for Vout=15V / 75uV for Vout=0.9V
- Soft startup and soft shutdown.
- Stable over a wide range of load capacitance (0.5uF to 50µF).
- Low temperature dependence (40 ppm/°C).
- Excellent line (0.015%/V) and load (0.15%/A) regulations.
- Monolithic design for high-reliability.
- Latch-up free.
- Ruggedized SMT and thru-hole packages.
- Also available as bare die.

### APPLICATIONS

- Reliability-critical, Automotive, Aeronautics & Aerospace, Down-hole.
- High-efficiency regulated power supplies, bridge excitation, cable- or battery-powered applications.

### DESCRIPTION

XTR70020 is a family of high-temperature, high-input voltage, 2Amp ultra low dropout voltage regulators designed for extreme reliability high voltage and high temperature applications. Being able to operate with input voltages from 3.0V to 30V, XTR70020 parts can source a current of 2A at +230°C while providing excellent regulation characteristics with a dropout as low as 1.2V. Several preset reference voltages are available from 0.6V to 15V allowing output voltages from 0.6V to virtually 30V.

Four protection features are implemented to ensure a good operation and reliability of the circuit: UVLO, hiccup modes short-circuit protection, customer selectable thermal shut-down, soft turn-on/off. XTR70020 parts can be used in a wide range of applications such as high fan-out and low-dropout regulators, adjustable power supply, current sources, as well as precision bridge excitation.

Special design techniques were used allowing XTR70020 parts to offer a precise, robust and reliable operation in critical applications. Full functionality is guaranteed from -60°C to +230°C, though operation well below and above this temperature range is achieved.

XTR70020 parts have been designed to reduce system cost and ease adoption by reducing the learning curve and providing smart and easy to use features.

Parts from the XTR70020 family are available in ruggedized SMT and thru-hole packages, as well as bare dies.

### PRODUCT HIGHLIGHT

#### VOUT selected using internal reference and resistor divider

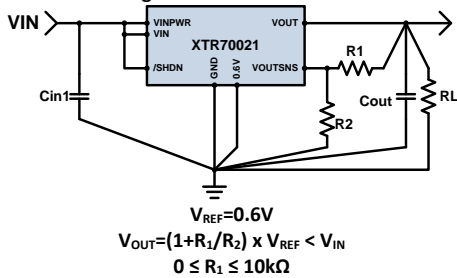

#### VOUT selected using internal reference only

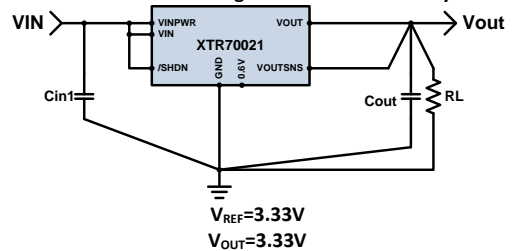

Typical applications with Kelvin connections on load and GND.

## ORDERING INFORMATION

X  
↓  
Source:  
X = X-REL Semi

TR  
↓  
Process:  
TR = HiTemp, HiRel

70  
↓  
Part family

02x  
↓  
Part number

x  
↓  
Output voltage  
(XTR70022 only)  
A = 0.6V J = 5.0V  
B = 0.8V K = 5.5V  
C = 0.9V L = 7.5V  
D = 1.2V M = 8.0V  
E = 1.8V N = 9.0V  
F = 2.2V O = 10V  
G = 2.5V P = 12V  
H = 2.8V Q = 13V  
I = 3.3V R = 15V

Product Reference	Temperature Range	Package	Pin Count	Marking
XTR70020-TD	-60°C to +230°C	Tested bare die		
XTR70021-FE	-60°C to +230°C	Gull-wing flat pack with ePad	10	XTR70021
XTR70022x-T	-60°C to +230°C	TO-254	3	XTR70022x
XTR70025-D	-60°C to +230°C	Ceramic side brazed DIP	8	XTR70025

Other output voltages, packages and packaging configurations possible upon request. For some packages or packaging configurations, MOQ may apply.

## ABSOLUTE MAXIMUM RATINGS

Voltage on VIN, VINPWR and /SHDN to GND	-0.5 to 35V
Voltage on any pin to GND	-0.5 to VIN
Storage Temperature Range	-60°C to +230°C
Operating Junction Temperature Range	-60°C to +300°C
ESD Classification	1kV HBM MIL-STD-883

**Caution:** Stresses beyond those listed in "ABSOLUTE MAXIMUM RATINGS" may cause permanent damage to the device. These are stress ratings only and functionality of the device at these or any other condition beyond those indicated in the operational sections of the specifications is not implied. Exposure to "ABSOLUTE MAXIMUM RATINGS" conditions for extended periods may permanently affect device reliability.

## PACKAGING

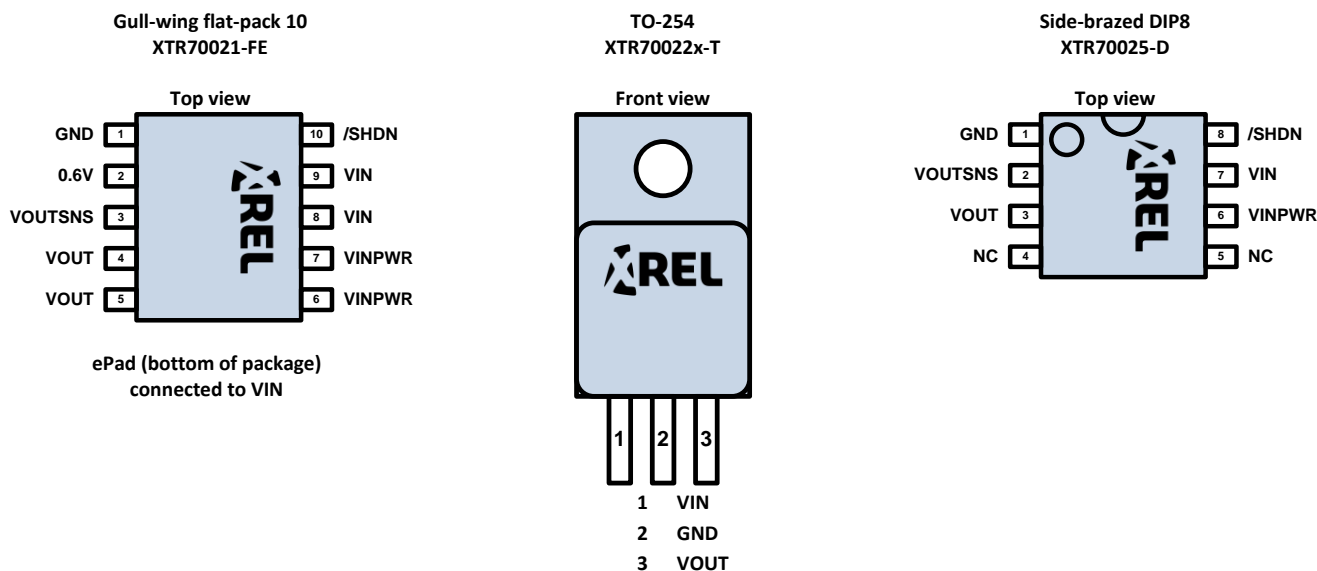

## BLOCK DIAGRAM

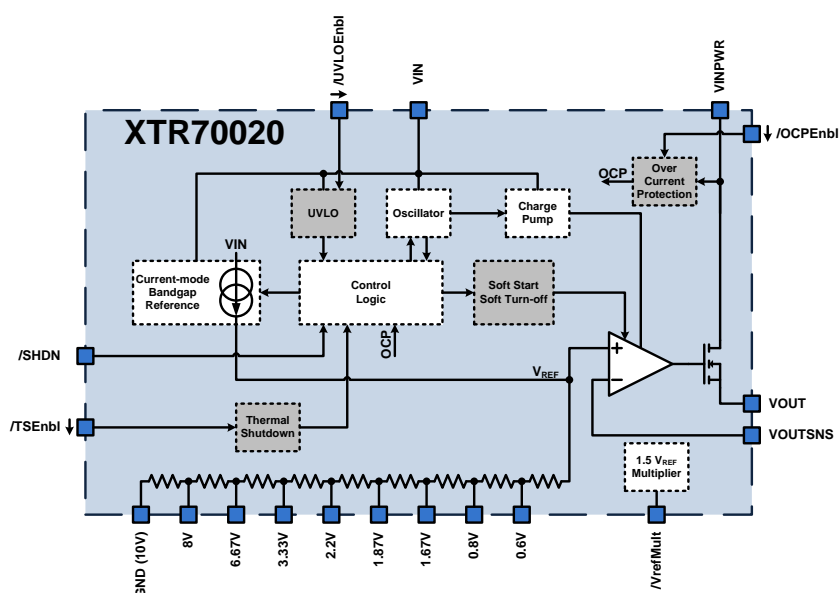

Different functionalities are available depending upon packaging configuration. Grey blocks represent the internal protections. Arrows aside pad names indicate the input is internally pulled down. Contact X-REL for the Die and Assembly Specifications document describing functionalities of all pads.

## PADS DESCRIPTION

Pad Name	Description
0.6V	Connect to GND to set $V_{REF}=0.6V$ .
0.8V	Connect to GND to set $V_{REF}=0.8V$ .
1.67V	Connect to GND to set $V_{REF}=1.67V$ .
1.87V	Connect to GND to set $V_{REF}=1.87V$ .
2.2V	Connect to GND to set $V_{REF}=2.2V$ .
3.33V	Connect to GND to set $V_{REF}=3.33V$ .
6.67V	Connect to GND to set $V_{REF}=6.67V$ .
8V	Connect to GND to set $V_{REF}=8V$ .
GND	Circuit ground. If no "x.xV" pad connected, default $V_{REF}$ is 10V.
/SHDN	Active-low shutdown functionality. Connect to VIN to enable the circuit or to GND to disable it. Do not leave floating (no internal pull).
/VrefMult	Multiplies the reference voltage selected by connecting any of xxV to GND by a factor of "3/2" (1.5). Left floating or connect to VOUTSNS if not used. <b>DO NEVER CONNECT</b> to other terminals than GND or VOUTSNS.
VOUTSNS	Output voltage sense (Kelvin connection). It can be directly connected to VOUT or used to set the output voltage by means of an external resistive divider.
VOUT	Output voltage terminal. Decouple to GND with a capacitor of at least 10nF.
VINPWR	Supply voltage of power transistor. Decouple to GND with a capacitor of at least 100nF.
VIN	Supply voltage of the internal blocks of the device. Connect directly to VINPWR pin or after a 10-100 $\Omega$ / 10-100nF low-pass filter.
/TSEnbl	Active-low thermal shut-down enable. Internally pulled down.
/OCPEnbl	Active-low over current protection enable. Internally pulled down.
/UVLOEnbl	Active-low UVLO enable. Internally pulled down.

## VREF SETTINGS

The following table is valid for the bare die of XTR70020 and assumes GND is connected to the 0V reference.

Voltage Selection Pads Connected to GND	/VrefMult Connection	Equivalent Reference Voltage
0.6V	Floating	0.6V
0.6V	GND	0.9V
0.8V	Floating	0.8V
0.8V	GND	1.2V
1.67V	Floating	1.67V
1.67V	GND	2.5V
1.87V	Floating	1.87V
1.87V	GND	2.8V
2.2V	Floating	2.2V
2.2V	GND	3.3V
3.33V	Floating	3.33V
3.33V	GND	5V
6.67V	Floating	6.67V
6.67V	GND	10V
8V	Floating	8V
8V	GND	12V
-	Floating	10V
-	GND	15V

When using the reference multiplier feature (/VrefMult is connected to GND) the maximum allowed R2 (see the “Basic Operation” section in page 11) is 10kΩ.

## PIN DESCRIPTION

XTR70021-FE		
Pin Number	Name	Description
1	GND	Circuit ground.
2	0.6V	Connect to GND to set $V_{REF}=0.6V$ .
3	VOUTSNS	Output voltage sense. Must be connected close to the load.
4	VOUT	Output voltage terminal. Decouple to GND with a capacitor of at least 500nF.
5		
6	VINPWR	Supply voltage terminal of power pass transistor.
7		
8	VIN	Supply voltage terminal.
9		
10	/SHDN	Active-low shut-down terminal. Connect to $V_{IN}$ when not used.

The default reference voltage ( $V_{REF}$ ) of XTR70021 is 3.33V. To change the reference voltage  $V_{REF}$  to 0.6V, connect pin “0.6V” to GND. See the “Basic Operation” section in page 11 for details on how to obtain any output voltage from the XTR70020 based on the internal settings and external components.

Internal Settings of XTR70021-FE		
Internal Pad	Internal Setting	Description
3.33V	GND	Default voltage set to 3.33V.
/VrefMult	Floating	Reference voltage multiplier disabled.
/TSEnbl	VIN	Thermal shut-down disabled.
/OCPEnbl	GND	Over-current (short-circuit) protection enabled.
/UVLOEnbl	GND	Under-voltage lockout (UVLO) enabled.

XTR70022x-T		
Pin Number	Name	Description
1	VIN	Supply voltage terminal.
2	GND	Circuit ground.
3	VOUT	Output voltage terminal. Decouple to GND with a capacitor of at least 500nF.

The output voltage ( $V_{OUT}$ ) of XTR70022 devices is set during the assembly of the parts. See the “Ordering Information” section to determine the part number corresponding to the needed output voltage in your application.

Internal Settings of XTR70022x-T		
Internal Pad	Internal Setting	Description
xxV	GND	Depends upon chosen part reference variant (A, B, C...).
/TSEnbl	VIN	Thermal shut-down disabled.
/OCPEnbl	GND	Over-current (short-circuit) protection enabled.
/UVLOEnbl	GND	Under-voltage lockout (UVLO) enabled.

XTR70025-D		
Pin Number	Name	Description
1	GND	Circuit ground.
2	VOUTSNS	Output voltage sense. Must be connected close to the load.
3	VOUT	Output voltage terminal. Decouple to GND with a capacitor of at least 500nF.
4	N.C.	No internal connection.
5	N.C.	No internal connection.

6	VINPWR	Supply voltage terminal of power pass transistor.
7	VIN	Supply voltage terminal.
8	/SHDN	Active-low shut-down terminal. Connect to V <sub>IN</sub> when not used.

The default reference voltage ( $V_{REF}$ ) of XTR70025 is 0.6V. See the “Basic Operation” section in page 11 for details on how to obtain any output voltage from the XTR70020 based on the internal settings and external components.

Internal Settings of XTR70025-D		
Internal Pad	Internal Setting	Description
0.6V	GND	Default reference voltage set to 0.6V.
/vrefMult	Floating	Reference voltage multiplier disabled.
/TSEnbl	GND	Thermal shut-down enabled.
/OCPEnbl	GND	Over-current (short-circuit) protection enabled.
/UVLOEnbl	GND	Under-voltage lockout (UVLO) enabled.

## THERMAL CHARACTERISTICS

Parameter	Condition	Min	Typ	Max	Units
<b>XTR70022-T</b>					
Thermal Resistance: J-C $R_{Th\_J-C}$	Measure on back of package.		5		°C/W
Thermal Resistance: J-A $R_{Th\_J-A}$	Still air.		50		°C/W
<b>XTR70025-D</b>					
Thermal Resistance: J-C $R_{Th\_J-C}$			25		°C/W
Thermal Resistance: J-A $R_{Th\_J-A}$			100		°C/W

## RECOMMENDED OPERATING CONDITIONS

Parameter	Min	Typ	Max	Units
Supply voltage $V_{IN}$	3.0		30	V
Load capacitance $C_{Load}$	0.5		50	μF
Recommended input decoupling capacitor $C_{dec}$		1		μF
Load current $I_{Load}$	100μ		2	A
Junction Temperature <sup>1</sup> $T_J$	-60		230	°C

<sup>1</sup> Operation beyond the specified temperature range is achieved

## ELECTRICAL SPECIFICATIONS

Unless otherwise stated, specification applies for  $V_{IN}=V_{INPWR}=20V$ ,  $V_{REF}=3.3V$  and  $V_{OUT}=5V$ ,  $-60^{\circ}C < T_C < 230^{\circ}C$ .

Parameter	Condition	Min	Typ	Max	Units
<b>Output Characteristics</b>					
Allowed Output Voltages $V_{OUT}$	$3.0V \leq V_{IN} \leq 30V$	0.6		$V_{IN} - 0.1$	V
Maximum Output Current $I_{OUT\_Max}$	XTR70020, XTR70021 and XTR70022 XTR70025 (Package limited)		2.0 0.7		A
Output Voltage Accuracy $\Delta V_{OUT}/V_{OUT}$	$I_{OUT}=10mA$ and $T_C=85^{\circ}C$	-3		+3	%
Minimum Reference Voltage Overhead <sup>1</sup> $V_{IN}-V_{REF}$	$3.0V \leq V_{IN} \leq 30V$		0.9	1.1	V
Dropout Voltage $V_{IN}-V_{OUT}$	$I_{OUT}=1A$ $T_C=-60^{\circ}C$ $T_C=85^{\circ}C$ $T_C=230^{\circ}C$		0.5 0.7 1.05		V
Drift with Temperature <sup>2</sup> $1/V_{OUT} \cdot (\Delta V_{OUT}/\Delta T)$		0	40	100	ppm/ $^{\circ}C$
Line Regulation <sup>2</sup> $1/V_{OUT} \cdot (\Delta V_{OUT}/\Delta V_{IN})$	$I_{LOAD} = 1mA$ at $T_C=230^{\circ}C$ (worst case) $V_{IN}$ from MAX[3V; $V_{OUT}+1V$ ] to 30V		0.015	0.08	%/V
Load regulation $1/V_{OUT} \cdot (\Delta V_{OUT}/\Delta I_{LOAD})$	$I_{LOAD}$ from 1mA to 1A, $(V_{IN} - V_{OUT}) = 2V$ $T_C=-60^{\circ}C$ $T_C=85^{\circ}C$ $T_C=230^{\circ}C$		0.15 0.05 0.11	0.7 0.4 0.3	%/A
<b>Current Consumption</b>					
Quiescent Ground Current $I_{GND}$	$T_C=230^{\circ}C$ (worst case) $V_{IN}-V_{OUT} \geq TH_{CPR}$ $V_{IN}-V_{OUT} < TH_{CPF}$		0.95 2.3	1.2 2.8	mA
Rising Charge Pump threshold $TH_{CPR}$	$V_{OUTREF}=0.6V$ $V_{OUTREF}=5V$ $V_{OUTREF}=10V$	4.8 5.1 5.65	5.4 5.7 6.25	6 6.3 6.85	V
Falling Charge Pump threshold $TH_{CPF}$	$V_{OUTREF}=0.6V$ $V_{OUTREF}=5V$ $V_{OUTREF}=10V$	4.0 4.1 4.15	4.7 4.8 4.85	5.4 5.5 5.55	V
Charge Pump threshold Hysteresis $TH_{CPH}$	$V_{OUTREF}=0.6V$ $V_{OUTREF}=5V$ $V_{OUTREF}=10V$	0.3 0.7 1.2	0.5 0.9 1.4	0.7 1.1 1.6	V
Standby Current $I_{std-By}$	/SHDN=0V, $T_C=230^{\circ}C$ (worst case) $T_C=-60^{\circ}C$ $T_C=85^{\circ}C$ $T_C=230^{\circ}C$		57 67 90	80 90 120	$\mu A$
<b>Shut-down Mode</b>					
Enable Voltage $V_{ON}$	/SHDN going up. $V_{IN}$ from 3.0V $V_{IN}$ from 5.0V to 30V		1.5 2.5	2 3.0	V
Shut-down Voltage $V_{OFF}$	/SHDN going down. $V_{IN}$ from 3.0V $V_{IN}$ from 5.0V to 30V	1 1.7	1.4 2.2		V
Shut-down Hysteresis $V_{SDH}$	/SHDN going up then down. $V_{IN}$ from 3.0V $V_{IN}$ from 5.0V to 30V		0.1 0.4		V
/SHDN Current $I_{/SHDN}$	$T_C=230^{\circ}C$ (Worst case) $V_{/SHDN}=0V$ $V_{/SHDN}=5V$	-10 -0.5		1 1	$\mu A$
<b>Digital Inputs (/TSEnbl, /OCPEnbl, /UVLOEnbl)</b>					
HIGH Level Input Voltage <sup>3</sup> $V_{IH}$	$V_{IN}=7V$ , $T_C=27^{\circ}C$		3.39		V
LOW Level Input Voltage <sup>3</sup> $V_{IL}$	$V_{IN}=7V$ , $T_C=27^{\circ}C$		1.91		V

<sup>1</sup> Reference voltage overhead is defined as the voltage difference between  $V_{IN}$  and  $V_{REF}$  to ensure a stable value on  $V_{REF}$ .

<sup>2</sup>  $\Delta V_{OUT}$  is defined as the worst-case output voltage variation ( $V_{OUT\_Max} - V_{OUT\_min}$ ) within the indicated range of temperature or input voltage.

<sup>3</sup> Guaranteed by design. Not tested in production.

## ELECTRICAL SPECIFICATIONS (CONTINUED)

Unless otherwise stated, specification applies for  $V_{IN}=V_{INPWR}=20V$ ,  $V_{REF}=3.3V$  and  $V_{OUT}=5V$ ,  $-60^{\circ}C < T_C < 230^{\circ}C$ .

Parameter	Condition	Min	Typ	Max	Units
<b>Short-circuit Protection</b>					
Over Current Threshold $I_{SC}$	$V_{OUTREF}=0.6V$ $V_{IN}=3V$ $V_{OUTREF}=15V$ $V_{IN}=17V$	1.6 1.5	2.6 2.3	3.5 3.3	A
OCP Hiccup Time <sup>1</sup> $t_{OCPH}$	$V_{OUTREF}=3.3V$ $V_{IN}=6V$ $T_C=-60^{\circ}C$ $T_C=85^{\circ}C$ $T_C=230^{\circ}C$		71 53 44		ms
<b>Under Voltage Lockout</b>					
$V_{IN}$ Start Voltage $V_{UVLOR}$	$V_{IN}$ going up. $V_{OUTREF}=0.6V$ $V_{OUTREF}=5V$		2.95 3.2	3.15 3.8	V
$V_{IN}$ Stop Voltage $V_{UVLOF}$	$V_{IN}$ going down.	2.60	2.75		V
$V_{IN}$ Start-stop Hysteresis $V_{UVLOH}$	$V_{IN}$ going up then down. $V_{OUTREF}=0.6V$ $V_{OUTREF}=5V$		150 500		mV
<b>Thermal Shut-down</b>					
Thermal shutdown <sup>2</sup>	Shutdown Restart	280 260	295 275	310 290	$^{\circ}C$
<b>Dynamic Characteristics</b>					
PSRR	DC to 100Hz, $I_{LOAD} = 150mA$ , $C_{LOAD} = 1.5\mu F$		-60		dB
Startup Delay from $V_{IN}$ $t_{st-up\_VIN}$	$/SHDN=V_{IN}$ , $V_{IN}$ swept from 0V to 15V with $t_r=100\mu s$ $T_C=-60^{\circ}C$ $T_C=85^{\circ}C$ $T_C=230^{\circ}C$		8.8 6.5 5.6		ms
Startup Delay from $/SHDN$ $t_{st-up\_SHDN}$	$V_{IN}=15V$ , $/SHDN$ swept from 0V to 5V with $t_r=100\mu s$ $T_C=-60^{\circ}C$ $T_C=85^{\circ}C$ $T_C=230^{\circ}C$		9.0 6.7 5.7		ms
Output Rise Time $t_r$	$/SHDN=V_{IN}$ , $V_{IN}$ swept from 0V to 15V with $t_r=100\mu s$ $C_{OUT}=2.5\mu F$ , $R_{LOAD}=1K\Omega$ .		0.5		ms
<b>Noise Characteristics</b>					
Integrated Voltage Noise $V_n$	$BW=10Hz$ to $100KHz$ , $R_{LOAD} = 100ohms$ , $C_{LOAD} = 2\mu F$ , $V_{IN}=5.5V$ $V_{OUT} = 0.9V$ $V_{OUT} = 3.3V$		21 34		$nV_{rms}$

<sup>1</sup> Time elapsed from the activation of the over-current (short-circuit) protection to the next start-up try.

<sup>2</sup> Thermal shut-down is disabled in packaged versions XTR70021 and XTR70022 and enabled in version XTR70025. It can be activated when using bare dies by setting  $/TSEnbl$  to GND (or left floating).



TYPICAL PERFORMANCE

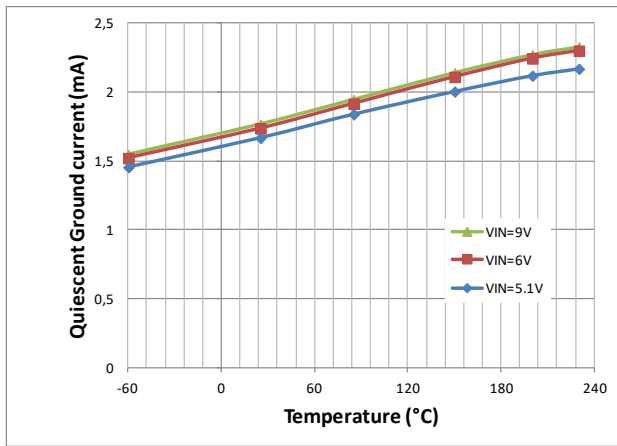

Figure 1. Quiescent Ground current ( $I_{GND}$ ) vs. case temperature for different supply voltage in Full power mode ( $V_{in}-V_{out}<5V$ ).  $V_{REF}=3.3V$  and  $V_{OUT}=5V$ .

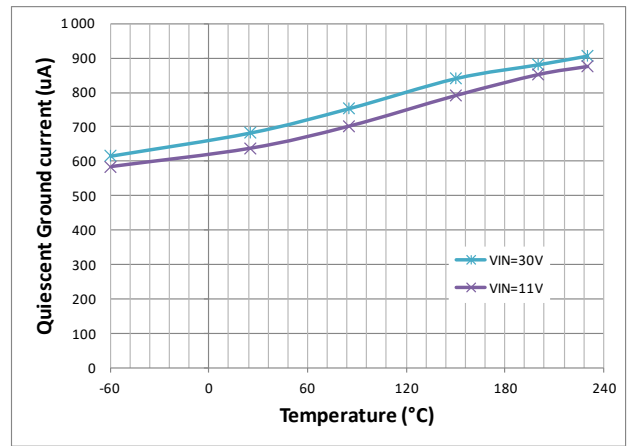

Figure 2. Quiescent Ground current ( $I_{GND}$ ) vs. case temperature for different supply voltage in Low power mode ( $V_{in}-V_{out}>5V$ ).  $V_{REF}=3.3V$  and  $V_{OUT}=5V$ .

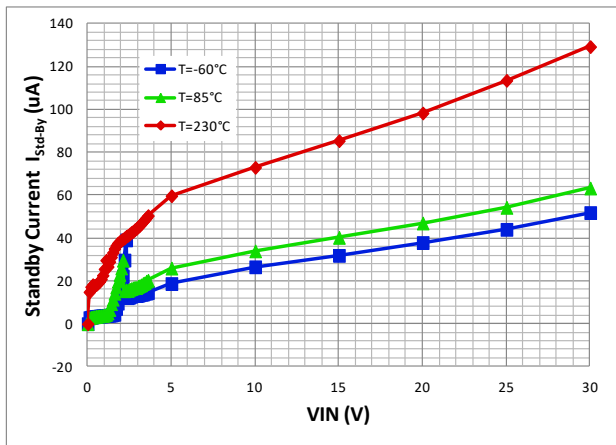

Figure 3. Stand-by current ( $I_{std-By}$ ) vs. supply voltage for different case temperatures.

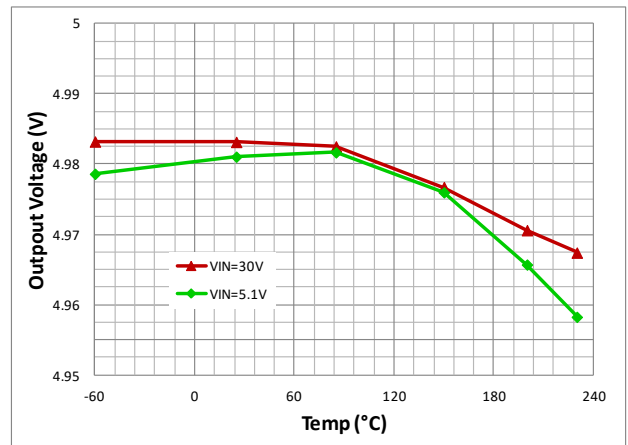

Figure 4. Output voltage ( $V_{OUT}$ ) vs. case temperature.  $R_{LOAD}=10k\Omega$ .

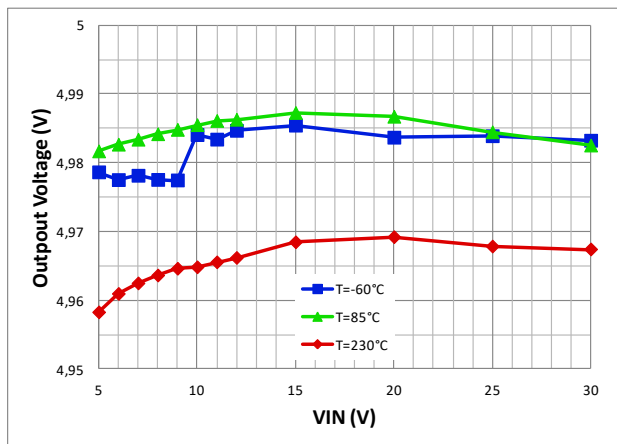

Figure 5. Output voltage ( $V_{OUT}$ ) vs supply voltage for different case temperatures.  $R_{LOAD}=10k\Omega$ .

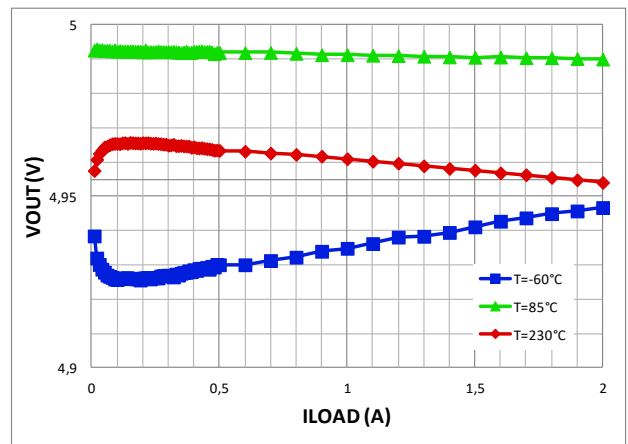

Figure 6. Output voltage ( $V_{OUT}$ ) vs supply voltage for different case temperatures.  $V_{REF}=3.3V$  and  $V_{OUT}=5V$  and  $V_{IN}=7V$ .

TYPICAL PERFORMANCE (CONTINUED)

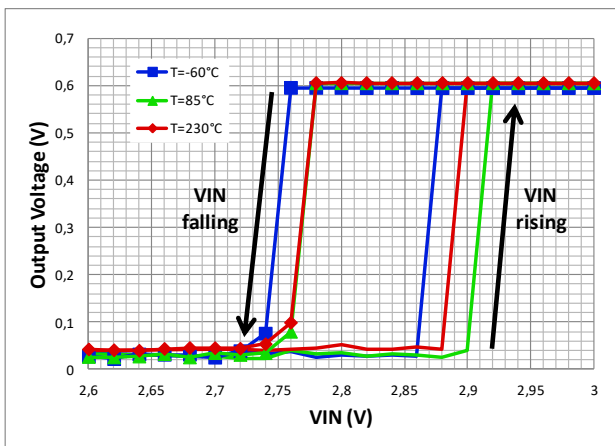

Figure 7. Output voltage ( $V_{OUT}$ ) vs supply voltage for different case temperatures.  $V_{REF}=V_{OUT}=0.6V$ ,  $R_{LOAD}=1K\Omega$ , UVLO enabled.

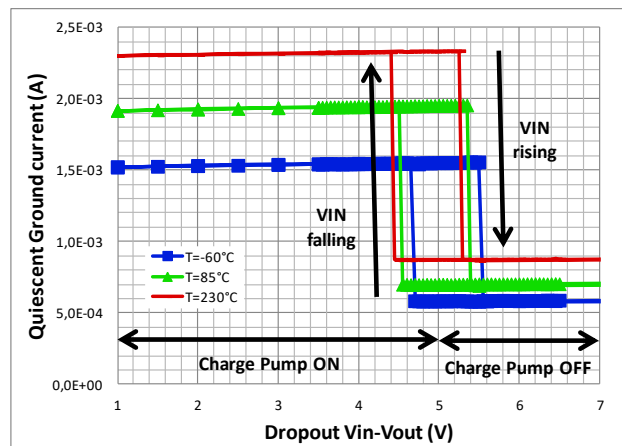

Figure 8. Ground current ( $I_{GND}$ ) vs dropout ( $V_{in}-V_{out}$ ) for different case temperatures.  $V_{REF}=3.3V$  and  $V_{OUT}=5V$ .

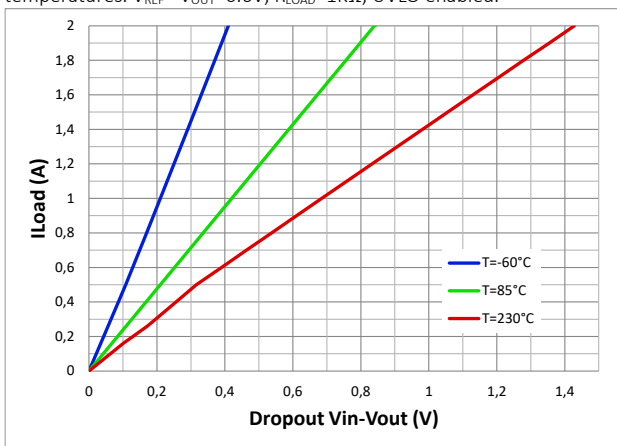

Figure 9. Maximum load current vs. dropout  $V_{in}-V_{out}$  for different case temperatures.  $V_{REF}=3.3V$  and  $V_{OUT}=5V$ .

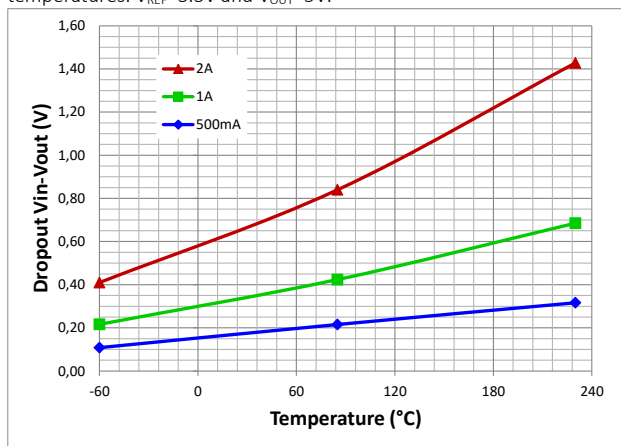

Figure 10. Minimum Dropout  $V_{in}-V_{out}$  vs. case temperature for different output current.  $V_{REF}=3.3V$  and  $V_{OUT}=5V$ .

## THEORY OF OPERATION

### Introduction

The XTR70020 is a family of high-current, low-dropout (high-efficiency), high-voltage linear regulators. Due to the high current level (>2A) that can be handled by this LDO regulator, several protections have been implemented in order to avoid damage resulting from fast load transient, output short circuits, excessive self-heating or insufficient input voltage.

In order to optimize the LDO dropout as well as the die size, the XTR70020 is based on an NMOS pass transistor, driven by a fully integrated charge pump.

The internal loop has been optimized for stable operation on any capacitive load type ranging from 0.5uF up to 50uF.

Once  $V_{IN}$  goes above the UVLO upper threshold and provided that the /SHDN input is high, the LDO is activated. An internal start-up delay is generated to ensure a smooth turn on. Thanks to a specific design of the output power NMOS, the output voltage will rise-up progressively without presenting any overshoot.

A separate VOUTSNS terminal is available for a precise sensing of the output voltage close to the load. This is particularly important at high current level to ensure a good load regulation. This sensing terminal can also be used for a fine tuning of the output voltage, using a resistive divider  $R_1/R_2$  between VOUT, VOUTSNS and GND ( $V_{refMult}$  should be floating in this case).

### Basic Operation

In XTR70020 products, a given output voltage can be obtained using two different possible architectures.

In the minimum footprint architecture, the output voltage is directly determined by setting the internal reference to the desired output voltage. Using only input and output decoupling networks, no resistive divider is needed to set the output voltage. This architecture is shown in the following image.

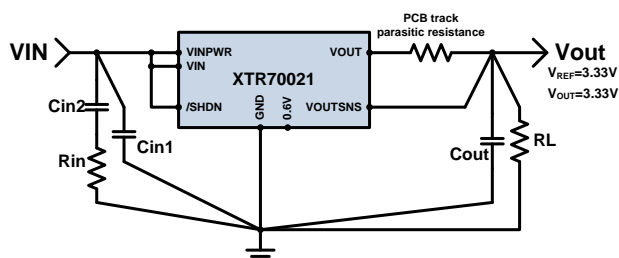

The previous image is based on the packaged version XTR70021-FE with reference voltage set to 3.33V by default. By connecting the VOUTSNS terminal (Kelvin feedback connection) to the output terminal VOUT, the output voltage  $V_{OUT}$  will also be 3.33V. This architecture needs, in all cases, an overhead ( $V_{IN} - V_{REF}$ ) of 0.9V (typ).

Another way to obtain a given output voltage is to set a given reference voltage  $V_{REF} < V_{OUT}$  and use a resistive divider between VOUT and VOUTSNS to set the necessary gain ( $V_{refMult}$  floating for XTR70021):

$$V_{OUT} = V_{REF} \times (1 + R_1/R_2)$$

The image below shows the typical application based on the XTR70021 and a resistive divider.

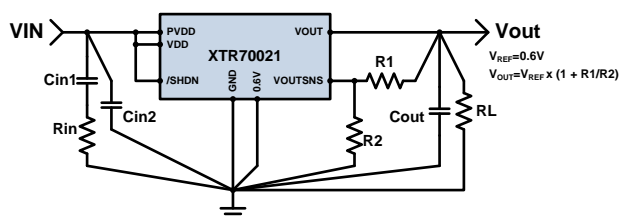

When setting the output voltage by means of a given  $V_{REF}$  and a resistive divider, the input voltage  $V_{IN}$  must satisfy the following conditions:

$$(V_{IN} - V_{REF}) > 0.9V$$

$$(V_{IN} - V_{OUT}) > \text{Min dropout for the given output current.}$$

When the feedback resistor  $R_1$  is connected directly on the load to reduce the effects of PCB or substrate tracks parasitic resistance, an AC bypass capacitor  $C_1$  (normally 1nF to 10nF) may be needed in parallel with  $R_1$ . This will compensate for the parasitic capacitance between VOUTSNS and GND, keeping a stable loop gain at high frequency for improved transient performance.

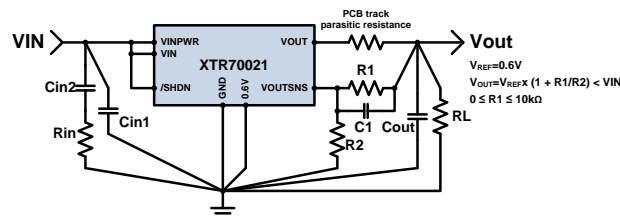

It is not recommended to use  $R_1 > 25R_2$  (exact ratio may vary depending upon parasitic capacitances) without  $C_1$  in parallel with  $R_1$ , as this could affect the loop stability condition.

If a fine tuning of  $V_{out}$  is required, it is recommended to select the internal  $V_{REF}$  level (with xxV pads) just below the expected  $V_{OUT}$ . Then, the  $R_1/R_2$  ratio is adjusted to obtain the requested  $V_{OUT}$ .

## Operation Modes

### Full-power mode

In order to optimize the LDO dropout as well as the die size, the XTR70020 is based on an NMOS pass device. A fully integrated charge pump is implemented. Thanks to this charge pump block, the gate of the NMOS pass transistor can be driven above the  $V_{IN}$  supply level.

Whenever  $V_{IN}-V_{OUT} < 5V$ , the internal charge pump is active. This is needed to ensure a sufficient drive voltage for the pass transistor to provide the maximum output current.

### Low-power mode

When  $V_{IN}-V_{OUT} > 5V$ , the pass transistor already has enough drive to be able to provide the maximum output current and the internal charge-pump remains off. By doing so, the intrinsic current consumption of the XTR70020 part becomes significantly smaller than during full-power operation mode.

### Operating mode with reference multiplier enabled

As explained above, whenever  $/V_{refMult}$  is left floating or connected to  $VO_{UTSNS}$  (connected or not to  $VO_{UT}$ ), any output voltage can be obtained by means of the following equation:

$$V_{OUT}=V_{REF} \times (1+R_1/R_2)$$

$V_{REF}$  is the reference voltage selected by the terminal  $xxV$  connected to GND and  $R_2$  is a non-zero resistor. Notice that  $R_1$  can be zero ( $VO_{UTSNS}$  directly connected to  $VO_{UT}$ ), in whose case  $V_{OUT}=V_{REF}$ .

If  $/V_{refMult}$  is directly connected to GND, the previous equation becomes:

$$V_{OUT}=3/2 \times V_{REF} \times (1+R_1/R_2)$$

$V_{REF}$  is the reference voltage selected by the terminal  $xxV$  connected to GND,  $R_2$  is a non-zero resistor and  $R_1$  can also be zero. If non-zero  $R_1$  is used, condition  $R_2 \leq 10k\Omega$  shall be satisfied.

## Functional Features and Protections

### Under voltage lockout (UVLO)

To prevent the regulator to start-up with insufficient supply voltages, UVLO functionality with a small hysteresis is implemented (see the Electrical Specification table). Below the threshold, the internal charge-pump and the LDO pass device are kept off. However, the part is not in stand-by mode.

Under voltage lockout functionality is active by default in all packaged versions ( $/UVLOEnbl$  internally pulled down). When using bare dies of the XTR70020, UVLO functionality can be deactivated by setting  $/UVLOEnbl$  to HIGH ( $V_{IN}$ ).

### Over-current / short circuit protection (OCP)

XTR70020 devices have “hiccup” mode over current / short circuit protection.

When the short circuit protection threshold is reached, the LDO’s pass device is progressively turned off (soft shut-down) in order to avoid fast current variations in parasitic inductors. Once off, the regulator remains in this state for about 60ms before a new soft-start cycle is tried. If the short circuit condition persists, the circuit will go again off and would try to soft restart, remaining in hiccup mode and presenting a low average DC current level until the short-circuit condition is no longer present.

The short-circuit protection functionality is active by default in all packaged versions ( $/OCPEnbl$  internally pulled down). When using bare dies of the XTR70020, OCP functionality can be deactivated by setting  $/OCPEnbl$  to HIGH ( $V_{IN}$ ).

### Thermal shut-down

XTR70020 devices have customer selectable thermal shutdown functionality. An internal circuitry is responsible for turning off the

internal charge-pump and the pass device when the junction temperature goes above a predefined limit (see the Electrical Specification table). The system will automatically restart as soon as the junction temperature comes back below the lower hysteresis threshold of the thermal shutdown protection.

Thermal shutdown functionality is disabled by default in the packaged versions XTR70021 and XTR70022 ( $/TSEnbl$  internally pulled up) and enabled in the XTR70025 ( $/TSEnbl$  floating). When using bare dies of the XTR70020, the thermal shutdown functionality can be activated by setting  $/TSEnbl$  to LOW (GND) or by leaving this pad floating.

## Application Considerations

### Input impedance quality factor

In applications with non-negligible parasitic inductance on the input supply line  $V_{IN}$ , it is recommended to use two decoupling capacitors of  $1\mu F$  in parallel, one of them with a small serial resistor ( $1\Omega$  to  $5\Omega$ ). Its purpose is to reduce the quality factor of the input parasitic LC circuit formed by the input wire inductor and  $C_{IN1}$ .

### Thermal considerations

The XTR70020 has an internal thermal shutdown protection that can be activated or not by the final user when using bare dies. For the thermal shut-down configuration of XTR70021, XTR70022 and XTR70025, please refer to Internal Settings tables in the “Pin Description” section.

In all cases, the user must ensure that the junction temperature does not exceed the temperature indicated in the Absolute Maximum Ratings and remain within the recommended temperature range whenever possible. Functionality can be achieved even above  $300^\circ C$  at the expenses of reducing product lifetime. However, in the packaged versions provided by X-REL Semiconductor, it is not recommended to operate the parts above  $250^\circ C$  for long periods.

### Ground connection

The XTR70020 ground pin should always be connected to the supply ground prior applying any input voltage. Accidental disconnecting of the ground terminal under operation could damage the part and its load.

Make sure that during operation the GND pin represents the minimum potential seen by any pin of the XTR70020 part.

### Regulator input shorting and input reversal

For a nominal output voltage  $V_{OUT} \geq 2.5V$ , connecting the input voltage to ground while the output capacitance is fully charged can create a large reverse current through the regulator pass element. If the load capacitance is large enough, the reverse current duration can be such that the regulator gets damaged.

Connecting the supply voltage in reverse polarity can damage the XTR70020. Take precautions when connecting the power supply lines. An external blocking diode can be added.

### Current sinking capabilities

XTR70020 parts **are not able** to sink any current. Doing so would pull the output voltage above its nominal value and could damage the regulator and its load.

### Testing on application boards

When testing the IC on an application board, connecting a capacitor to a pin while the XTR70020 is operating may subject the part to stress.

Always discharge capacitors after each process or step. Always turn the power supply off before connecting or removing the XTR70020 from test fixture.

Ground the XTR70020 during assembly steps as an antistatic measure. Use similar precaution when transporting or storing the XTR70020.

## PACKAGE OUTLINES

Dimensions shown in mm [inches]. Tolerances  $\pm 0.13$  mm [ $\pm 0.005$  in] unless otherwise stated.

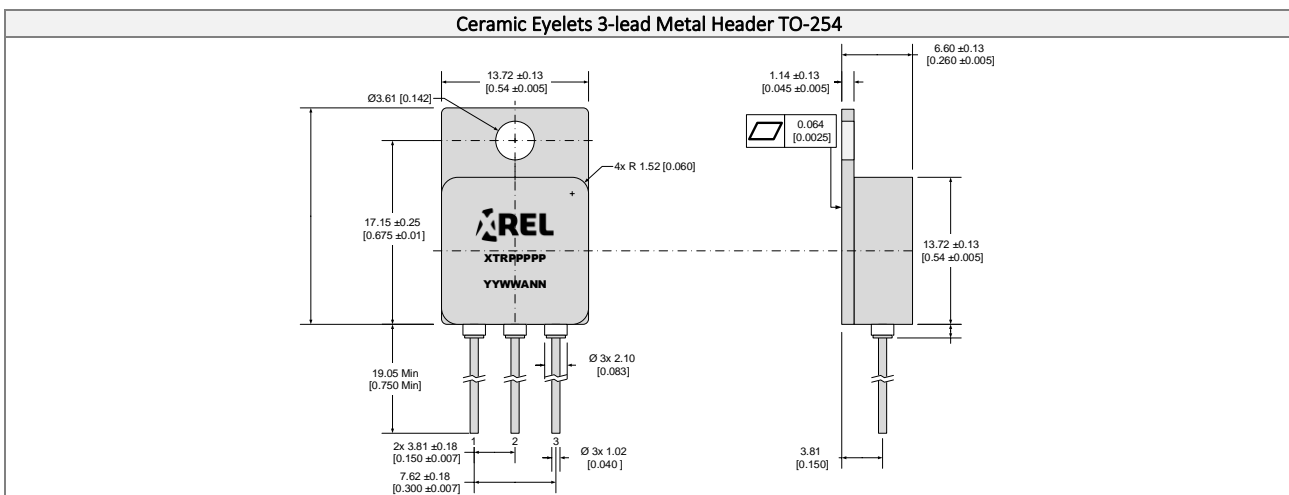
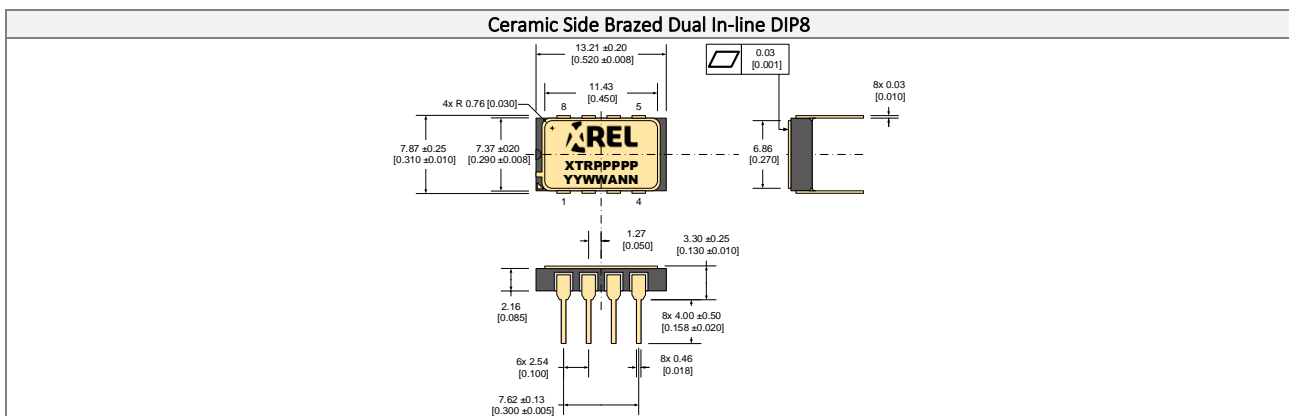
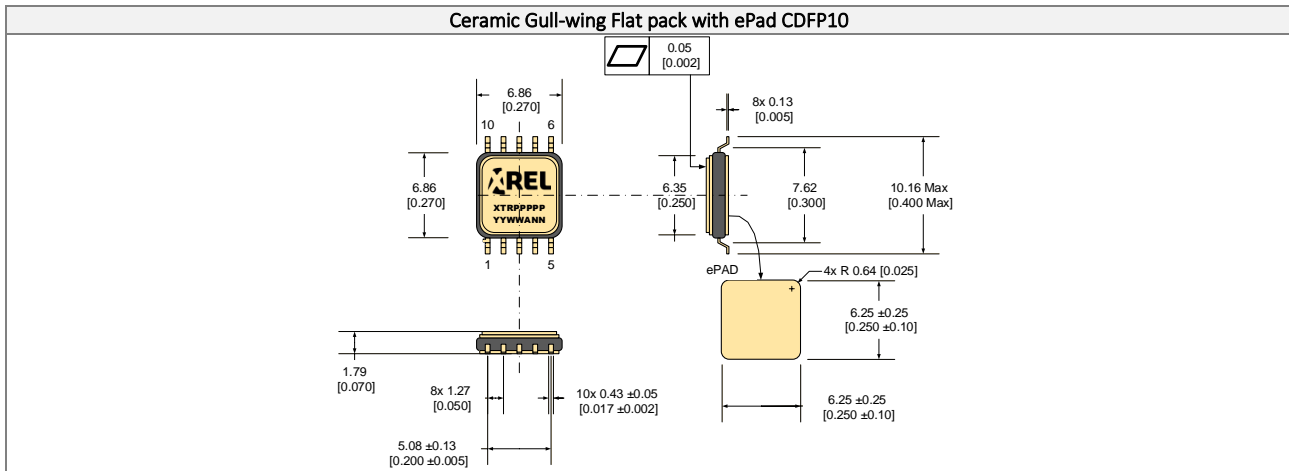

### Part Marking Convention

<b>Part Reference: XTRPPPPP</b>	
<b>XTR</b>	X-REL Semiconductor, high-temperature, high-reliability product (XTRM Series).
<b>PPPPP</b>	Part number (0-9, A-Z).
<b>Unique Lot Assembly Code: YYWWANN</b>	
<b>YY</b>	Two last digits of assembly year (e.g. 11 = 2011).
<b>WW</b>	Assembly week (01 to 52).
<b>A</b>	Assembly location code.
<b>NN</b>	Assembly lot code (01 to 99).

## IMPORTANT NOTICE & DISCLAIMER

---

Information in this document supersedes and replaces all information previously supplied. Information in this document is provided solely in connection with EASii IC products from the X-REL business unit.

The information contained herein is believed to be reliable. EASii IC makes no warranties regarding the information contained herein. EASii IC assumes no responsibility or liability whatsoever for any of the information contained herein. EASii IC assumes no responsibility or liability whatsoever for the use of the information contained herein. The information contained herein is provided "AS IS, WHERE IS" and with all faults, and the entire risk associated with such information is entirely with the user. EASii IC reserves the right to make changes, corrections, modifications or improvements, to this document and the information herein without notice. Customers should obtain and verify the latest relevant information before placing orders for EASii IC products. The information contained herein or any use of such information does not grant, explicitly or implicitly, to any party any patent rights, licenses, or any other intellectual property rights, whether with regard to such information itself or anything described by such information.

Unless expressly approved in writing by an authorized representative of EASii IC, EASii IC products are not designed, authorized or warranted for use in military, aircraft, space, lifesaving, or life sustaining applications, nor in products or systems where failure or malfunction may result in personal injury, death, or property or environmental damage.

General Sales Terms & Conditions apply.

For product information and a complete list of distributors, please go to our web site: [www.x-relsemi.com](http://www.x-relsemi.com)



90, Avenue Leon Blum 38100 Grenoble — France

☎ : +33 456 580 580

✉ : support.XREL@easii-ic.com

EASii IC, X-REL Semiconductor, and the logo are trademarks of EASii IC in France and other countries.  
Data subject to change. Copyright © 2002-2021 EASii IC. All rights reserved.