



XTR70010

High-Temperature 1.5A Low-Dropout Voltage Regulator

Rev 4 – August 2021 (DS-00297-12)

Data Sheet



PRODUCTION



FEATURES

- Operational beyond the -60°C to +230°C temperature range.
- Input voltages from 2.8V to 5.5V.
- High output current with low dropout: 1.5A @ 230°C with 1.9V dropout (1A with 1.2V dropout)
- Up to 32 possible discrete output voltages from same part:
 - From 0.5V to 3.6V by step of 100mV.
- Possible Vout selection based on an external resistive divider.
- No minimum dropout imposed (current limited).
- Low current consumption in full-power (1.3mA), low-power modes (550µA) and stand-by (<20µA) modes.
- Output Overshoot Remover system.
- Over current protection (hiccup mode).
- Customer selectable Thermal Shutdown protection.
- Customer selectable Thermal Shutdown threshold.
- UVLO protection.
- Power supply protection for insufficiently decoupled networks.
- Accurate bandgap reference (+/-4%).
- Low noise under 45µVrms typ.
- Soft startup and soft shutdown.
- Stable over a wide range of load capacitance (10nF to 33µF).
- Low temperature dependence (20 ppm/°C).
- Excellent line regulation (<0.25%/V @ 230°C).
- Excellent load regulation (<2.6%/A @ 230°C).
- Monolithic design for high-reliability.
- Latch-up free.
- Ruggedized SMT and thru-hole packages.
- Also available as tested die.

DESCRIPTION

XTR70010 is a family of low-power voltage regulators/references designed for extreme reliability and high temperature applications. Being able to operate with input voltages from 2.8V to 5.5V, XTR70010 parts can source a current of 1.5A at +230°C while providing excellent regulation characteristics with a dropout as low as 1.9V. Moreover, it can supply a large range of output voltages from 0.5V to 3.6V thanks to an accurate current mode bandgap reference.

Six protection systems are implemented to ensure a good operation and reliability of the circuit: UVLO, Short-circuit hiccup mode, thermal shutdown, fast output overshoot killer, soft turn-off and power supply supervision in case of bad input decoupling.

XTR70010 parts can be used on a wide range of applications such as high fan-out and low dropout regulators/references, adjustable power supply, current sources, as well as precision bridge excitation.

Special design techniques were used allowing XTR70010 parts to offer a precise, robust and reliable operation in critical applications. Full functionality is guaranteed from -60°C to +230°C, though operation well below and above this temperature range is achieved.

XTR70010 parts have been designed to reduce system cost and ease adoption by reducing the learning curve and providing smart and easy to use features.

Parts from the XTR70010 family are available in ruggedized SMT and thru-hole packages. Parts are also available as tested dies.

APPLICATIONS

- Reliability-critical, Automotive, Aeronautics & Aerospace, Down-hole.
- High-efficiency regulated power supplies, bridge excitation, cable- or battery-powered applications.

PRODUCT HIGHLIGHT

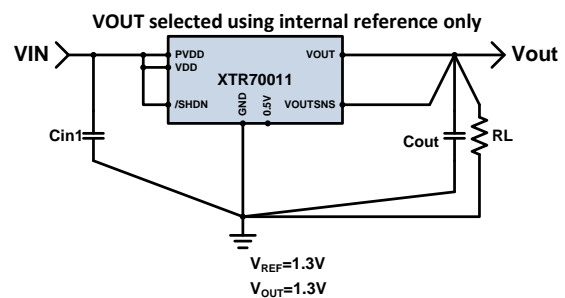
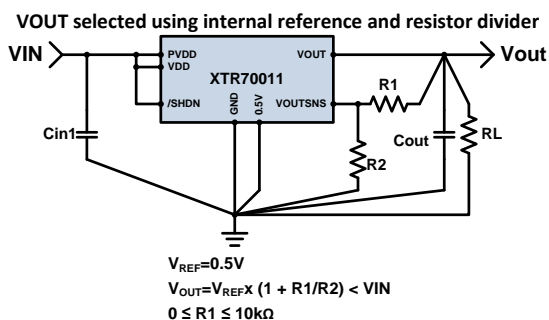

ORDERING INFORMATION

X
↓
Source :
X=X-REL Semi

TR
↓
Process:
TR=HiTemp, HiRel

70
↓
Part family

010
↓
Part number

Product Reference	Temperature Range	Package	Pin Count	Marking
XTR70010-TD	-60°C to +230°C	Tested bare die		
XTR70011-FE	-60°C to +230°C	Gull-wing flat pack with ePad	10	XTR70011
XTR70015-D	-60°C to +230°C	Ceramic side brazed DIP	8	XTR70015

Other output voltages, packages and packaging configurations possible upon request. For some packages or packaging configurations, MOQ may apply.

ABSOLUTE MAXIMUM RATINGS

Voltage on VDD, PVDD, to GND	-0.5V to 6V
Voltage on any pin to GND	-0.5V to 6V
Storage Temperature Range	-60°C to +230°C
Operating Junction Temperature Range	-60°C to +300°C
ESD Classification	1kV HBM MIL-STD-883

Caution: Stresses beyond those listed in "ABSOLUTE MAXIMUM RATINGS" may cause permanent damage to the device. These are stress ratings only and functionality of the device at these or any other condition beyond those indicated in the operational sections of the specifications is not implied. Exposure to "ABSOLUTE MAXIMUM RATINGS" conditions for extended periods may permanently affect device reliability.

PINOUT

Ceramic Dual Flat-Pack 10
XTR70011-FE

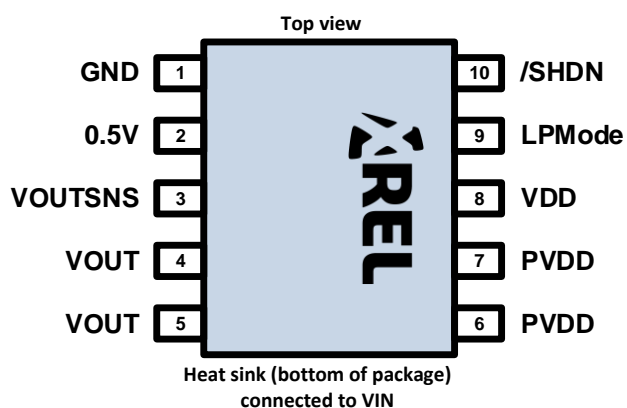

Ceramic Side-brazed DIP8
XTR70015-D

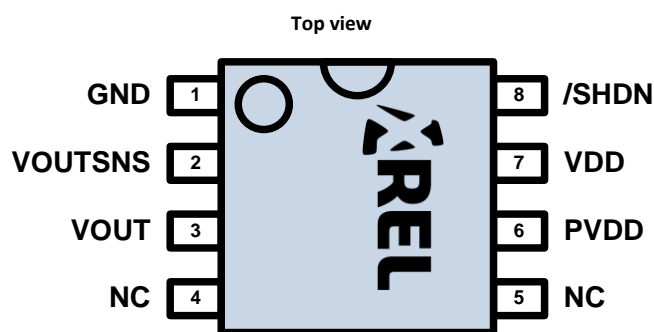

BLOCK DIAGRAM

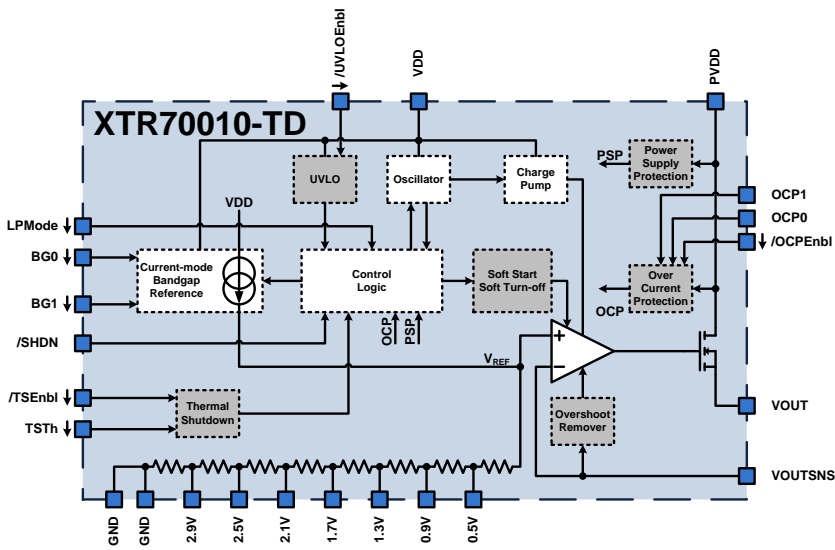

Die-level block diagram showing all available functionalities and bond-pads. Arrows aside pad names indicate the input is internally pulled down. Contact X-REL for the Die and Assembly Specifications document describing all pads functionalities.

PADS DESCRIPTION

Pad Name	Description
2.9V	Connect to GND to set $V_{REF}=2.9V$.
2.5V	Connect to GND to set $V_{REF}=2.5V$.
2.1V	Connect to GND to set $V_{REF}=2.1V$.
1.7V	Connect to GND to set $V_{REF}=1.7V$.
1.3V	Connect to GND to set $V_{REF}=1.3V$.
0.9V	Connect to GND to set $V_{REF}=0.9V$.
0.5V	Connect to GND to set $V_{REF}=0.5V$.
GND	Circuit ground. Connect both bond pads. If no "x.xV" pad connected, default V_{REF} is 3.3V.
BG1	Adds 200mV to V_{REF} if connected to VDD. Cumulative effect with BG0. Internally pulled down. See VREF Settings section for details.
BG0	Adds 100mV to V_{REF} if connected to VDD. Cumulative effect with BG1. Internally pulled down. See VREF Settings section for details.
/SHDN	Active-low shutdown functionality. Connect to VDD to enable the circuit or to GND to disable it. Do not leave floating (no internal pull).
LPMODE	Active-high low-power mode. Internally pulled down (full-power mode by default).
VOUTSNS	Output voltage sense (Kelvin connection). It can be directly connected to VOUT ($V_{OUT}=V_{REF}$) or used to set the output voltage by means of an external resistive divider.
VOUT	Output voltage terminal. Decouple to GND with a capacitor of at least 10nF.
PVDD	Supply voltage of power transistor. Decouple to GND with a capacitor of at least 100nF.
VDD	Supply voltage of the analog blocks of the device. Connect directly to PVDD pin or after a 10-100 Ω / 10-100nF low pass filter.
/TSENbl	Active-low thermal shut-down enable. Internally pulled down.
TSTh	Thermal shut-down threshold selector: 325°C if LOW, 245°C if HIGH. Internally pulled down.
OCPO	LSB of Over Current Protection trimming feature. See table on OCP0/OCP1 usage in the Die and Assembly Specifications document.
OCP1	MSB of Over Current Protection trimming feature. See table on OCP0/OCP1 usage in the Die and Assembly Specifications document.
/OCPEnbl	Active-low over current protection enable. Internally pulled down.
/UVLOEnbl	Active-low UVLO enable. Internally pulled down.

OVERCURRENT PROTECTION (OCP) SETTINGS

OCP1	OCPO	Typical over current protection threshold
0	0	1.9 Amp
0	1	2.1 Amp
1	0	1.7 Amp
1	1	1.5 Amp

THERMAL SHUT-DOWN SETTINGS

/TSENbl	TSTh	Typical thermal shut-down threshold
0	0	325°C
0	1	245°C
1	x	Thermal shut-down disabled

VREF SETTINGS

XTR70010-TD			
Pads Connected to Ground	BG1	BG0	Reference Voltage
GND + 0.5V	0	0	0.5V
GND + 0.5V	0	1	0.6V
GND + 0.5V	1	0	0.7V
GND + 0.5V	1	1	0.8V
GND + 0.9V	0	0	0.9V
GND + 0.9V	0	1	1.0V
GND + 0.9V	1	0	1.1V
GND + 0.9V	1	1	1.2V
GND + 1.3V	0	0	1.3V
GND + 1.3V	0	1	1.4V
GND + 1.3V	1	0	1.5V
GND + 1.3V	1	1	1.6V
GND + 1.7V	0	0	1.7V
GND + 1.7V	0	1	1.8V
GND + 1.7V	1	0	1.9V
GND + 1.7V	1	1	2.0V
GND + 2.1V	0	0	2.1V
GND + 2.1V	0	1	2.2V
GND + 2.1V	1	0	2.3V
GND + 2.1V	1	1	2.4V
GND + 2.5V	0	0	2.5V
GND + 2.5V	0	1	2.6V
GND + 2.5V	1	0	2.7V
GND + 2.5V	1	1	2.8V
GND + 2.9V	0	0	2.9V
GND + 2.9V	0	1	3.0V
GND + 2.9V	1	0	3.1V
GND + 2.9V	1	1	3.2V
GND	0	0	3.3V
GND	0	1	3.4V
GND	1	0	3.5V
GND	1	1	3.6V

PIN DESCRIPTION

XTR70011-FE		
Pin Number	Name	Description
1	GND	Circuit ground.
2	0.5V	Connect to GND to set $V_{REF}=0.5V$.
3	VOUTSNS	Output voltage sense. Must be connected close to the load.
4	VOUT	Output voltage terminal. Decouple to GND with a capacitor of at least 10nF.
5		
6	PVDD	Supply voltage of power transistor. Decouple to GND with a capacitor of at least 100nF.
7		
8	VDD	Supply voltage of the analog blocks of the device. Connect directly to PVDD pin or after a 10-100 Ω / 10-100nF low pass filter.
9	LPMODE	Active-high low-power mode. Internally pulled down (full-power mode by default).
10	/SHDN	Active-low shut-down terminal. Connect to VDD when not used.

The default reference voltage (V_{REF}) of XTR70011 is 1.3V. To change the reference voltage V_{REF} to 0.5V, connect pin "0.5V" to GND. See the "Basic Operation" section in page 14 for details on how to obtain any output voltage from the XTR70010 based on the internal settings and external components.

Internal Settings of XTR70011-FE		
Internal Pad	Internal Setting	Description
BG1	GND	Default voltage set to 1.3V.
BG0	GND	
1.3V	GND	
/TSEnbl	VDD	Thermal shut-down disabled.
/OCPEnbl	GND	Over-current (short-circuit) protection enabled.
OCP0	VDD	Over-current (short-circuit) protection threshold set to 2.1Amp.
OCP1	GND	
/UVLOEnbl	GND	Under-voltage lockout (UVLO) enabled.

PIN DESCRIPTION (CONTINUED)

XTR70015-D		
Pin Number	Name	Description
1	GND	Circuit ground.
2	VOOTSNS	Output voltage sense. Must be connected close to the load.
3	VOUT	Output voltage terminal. Decouple to GND with a capacitor of at least 10nF.
4	NC	No Internal connection.
5	NC	No Internal connection.
6	PVDD	Supply voltage of power transistor. Decouple to GND with a capacitor of at least 100nF.
7	VDD	Supply voltage of the analog blocks of the device. Connect directly to PVDD pin or after a 10-100Ω / 10-100nF low pass filter.
8	/SHDN	Active-low shut-down terminal. Connect to VDD when not used.

The default reference voltage (V_{REF}) of XTR70015 is 0.5V. See the “Basic Operation” section in page 14 for details on how to obtain any output voltage from the XTR70010 based on the internal settings and external components.

Internal Settings of XTR70015-D		
Internal Pad	Internal Setting	Description
BG1	GND	Default voltage set to 0.5V.
BG0	GND	
0.5V	GND	
/TSEnbl	GND	Thermal shut-down enabled.
TSTh	GND	Thermal shut-down threshold set to 310°C.
/OCPEnbl	GND	Over-current (short-circuit) protection enabled.
OCP0	VDD	Over-current (short-circuit) protection threshold set to 1.5Amp.
OCP1	VDD	
/UVLOEnbl	GND	Under-voltage lockout (UVLO) enabled.

THERMAL CHARACTERISTICS

Parameter	Condition	Min	Typ	Max	Units
XTR70011-SH					
Thermal Resistance: J-C R_{Th_J-C}	Measured on Heat Sink.		4		°C/W
Thermal Resistance: J-A R_{Th_J-A}	Heat Sink thermally connected to 3cm ² PCB copper.		70		°C/W
XTR70015-D					
Thermal Resistance: J-C R_{Th_J-C}			25		°C/W
Thermal Resistance: J-A R_{Th_J-A}			100		°C/W

RECOMMENDED OPERATING CONDITIONS

Parameter	Min	Typ	Max	Units
Supply voltage V_{DD}	2.8		5.5	V
Voltage on /SHDN to GND	0		V _{DD}	V
Voltage on LPMODE to GND	0		V _{DD}	V
Voltage on VO _{UTS} NS to GND	0		V _{OUT}	V
Load current I_{Load}	100μ		1.5	A
Load capacitance C_{Load}	0.01	1	33	μF
Recommended input decoupling capacitor ¹ C_{IN1}	0.1	1		μF
Junction Temperature ² T_J	-60		230	°C

¹ In systems with inductive input connections, keep input inductance below 1μH and add bypass capacitor C_{IN2}=C_{IN1} with a series resistor of 1-2Ω. See the "Basic Operation" section in page 14 for detail.

² Operation beyond the specified temperature range is achieved.

ELECTRICAL SPECIFICATIONS

Unless otherwise stated, specification applies for $V_{DD}=PV_{DD}=5V$, $-60^{\circ}C < T_C < 230^{\circ}C$.

Parameter	Condition	Min	Typ	Max	Units
Output Voltages					
Preset Reference Voltages V_{REF}	$V_{DD}-V_{REF}>0.9V$	0.5V to 3.6V in steps of 0.1V			
Allowed Output Voltages V_{OUT}	$V_{DD}-V_{REF}>0.9V$	0.5V to VDD			
Output Characteristics					
Maximum Output Current I_{OUT_Max}	XTR70010 and XTR70011 XTR70015 (Package limited)	1.5 0.6	1.8 0.7		A
Output Voltage Accuracy $\Delta V_{OUT}/V_{OUT}$	$I_{OUT}=10mA$	-4		+4	%
Minimum Reference Voltage Overhead ¹ $V_{DD}-V_{REF}$	$2.8V \leq V_{DD} \leq 5.5V$		0.9	1.1	V
Dropout Voltage $V_{DD}-V_{OUT}$	$I_{OUT}=1A$ $T_C=-60^{\circ}C$ $T_C=85^{\circ}C$ $T_C=230^{\circ}C$		0.6 0.9 1.2	0.8 1.1 1.4	V
Drift with Temperature ² $1/V_{OUT} \cdot (\Delta V_{OUT}/\Delta T)$			20	50	ppm/ $^{\circ}C$
Line Regulation ² $1/V_{OUT} \cdot (\Delta V_{OUT}/\Delta V_{DD})$	$2.8V \leq V_{DD} \leq 5.5V$, $R_{LOAD}=1k\Omega$ $V_{REF}=V_{OUT}=0.5V$ $V_{REF}=V_{OUT}=1.8V$ $V_{REF}=V_{OUT}=3.6V$	-0.06 -0.14 -0.25		0.06 0.14 0.25	%/V
Load regulation $1/V_{OUT} \cdot (\Delta V_{OUT}/\Delta I_{LOAD})$	$V_{DD}=5.5V$ (worst case configuration) I_{LOAD} from 1mA to 1.5A $T_C=-60^{\circ}C$ $T_C=85^{\circ}C$ $T_C=230^{\circ}C$		0.9 1.4 2.1	1.4 1.8 2.6	%/A
Current Consumption					
Quiescent Ground Current I_{GND}	$T_C=230^{\circ}C$; $V_{DD}=5.5V$ Full-power mode (LPMode=GND) Low-power mode (LPMode=VDD)		1.35 0.55	1.60 0.63	mA
Standby Current I_{std-By}	/SHDN=0V, $V_{DD}=5.5V$ $T_C=-60^{\circ}C$ $T_C=85^{\circ}C$ $T_C=230^{\circ}C$		1.5 2.1 17	4 6 25	μA
Shut-down Mode					
Enable Voltage V_{ON}	/SHDN going up $V_{DD}=2.8V$ $V_{DD}=5.5V$	1.75 3.30	1.95 3.60	2.15 3.90	V
Shut-down Voltage V_{OFF}	/SHDN going down $V_{DD}=2.8V$ $V_{DD}=5.5V$	0.75 1.60	1.00 1.80	1.20 2.00	V
Shut-down Hysteresis V_{SDH}	$V_{DD}=2.8V$ $V_{DD}=5.5V$	0.80 1.50		1.20 2.00	V
/SHDN Current $I_{/SHDN}$	$T_C=230^{\circ}C$ (Worst case) XTR70010 XTR70011 XTR70015	-0.04 -1 -2		0.04 8 16	μA
Short-circuit Protection					
Over Current Protection Threshold ³ I_{sc}	XTR70011 (highest protection threshold) XTR70015 (lowest protection threshold)	1.6 1.0	2.1 1.5	2.6 1.9	A
OCF Hiccup Time ⁴ t_{OCPH}	$T_C=-60^{\circ}C$ $T_C=85^{\circ}C$ $T_C=230^{\circ}C$		59 44 37		ms
Input Oscillation Protection					
Activation Bandwidth		50		2000	kHz
Activation Oscillation Amplitude		0.35			V _p

¹ Reference voltage overhead is defined as the voltage difference between V_{DD} and V_{REF} to ensure a stable value on V_{REF} .

¹ ΔV_{OUT} is defined as the worst-case output voltage variation ($V_{OUT_Max} - V_{OUT_min}$) within the indicated range of temperature or input voltage.

¹ The OCP threshold depends on the OCP0/OCP1 pad settings. See the "Overcurrent Protection (OCP) Settings" section in page 4 for detail.

¹ Time elapsed from the activation of the over-current (short-circuit) protection to the next start-up try.

ELECTRICAL SPECIFICATIONS (CONTINUED)

Unless otherwise stated, specification applies for $V_{DD}=PV_{DD}=5V$, $-60^{\circ}C < T_C < 230^{\circ}C$.

Under Voltage Lockout					
V _{DD} Start Voltage V_{UVLOR}	V _{DD} going up.		2.65	2.80	V
V _{DD} Stop Voltage V_{UVLOF}	V _{DD} going down.	2.30	2.50		V
V _{DD} Start-stop Hysteresis V_{UVLOH}	V _{DD} going up then down.		150		mV
Thermal Shut-down					
Thermal Shutdown ¹	TSTh to GND or left floating Shutdown	315	325	335	°C
	Restart	280	295	310	
	TSTh to VDD Shutdown	230	245	260	
	Restart	200	215	225	
Dynamic Characteristics					
Startup Delay from VDD t_{st-up_VDD}	/SHDN to VDD, V _{DD} swept from 0V to 5V with t _r =100μs T _C =-60°C T _C =85°C T _C =230°C		8.9 6.6 5.5		ms
Startup Delay from /SHDN t_{st-up_/SHDN}	V _{DD} =2.8V, /SHDN swept from 0V to V _{DD} with t _r =100μs T _C =-60°C T _C =85°C T _C =230°C		7.9 6.2 5.0		ms
Output Rise Time t_r	/SHDN to VDD, V _{DD} swept from 0V to 5V with t _r =100μs V _{OUT} =1.8V, C _{OUT} =1μF, R _{LOAD} =220Ω. T _C =-60°C T _C =85°C T _C =230°C		2.0 1.5 1.3		ms
Input Voltage Rejection PSRR	C _{OUT} =0.1μF, I _{OUT} =10mA. Freq=DC to 100Hz Freq=1kHz	-60 -40			dB
Noise Characteristics					
Integrated Voltage Noise V_n	V _{DD} =5.5V, V _{OUT} =0.5V, C _{OUT} =1μF, R _{LOAD} =1kΩ. BW=0.1Hz to 10Hz. T _C =-60°C T _C =85°C T _C =230°C		45 32 28		μV _{rms}
Spectral Density	V _{DD} =5.5V, V _{OUT} =0.5V, C _{OUT} =1μF, R _{LOAD} =1kΩ. Freq=100Hz. T _C =-60°C T _C =85°C T _C =230°C		1.4 0.9 0.7		μV/√Hz

¹ Thermal shut-down is disabled in packaged version XTR70011 and enabled, with threshold 325°C, in XTR70015. Thermal shut-down function is activated when /TSENbl to GND (or left floating). TSTh is an internal pad.

TYPICAL PERFORMANCE

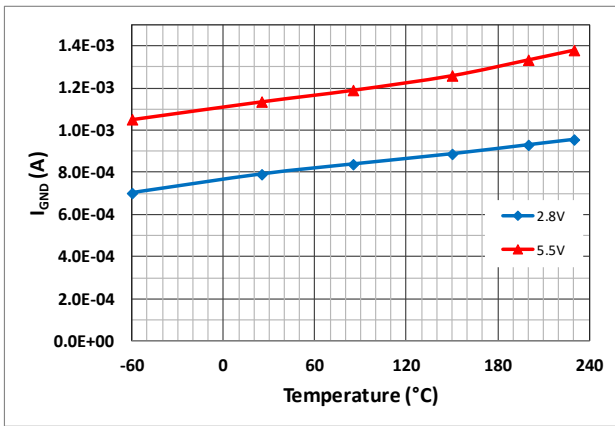

Figure 1. Ground current (I_{GND}) in full-power mode (LPMode=GND) vs. case temperature for extreme supply voltages.

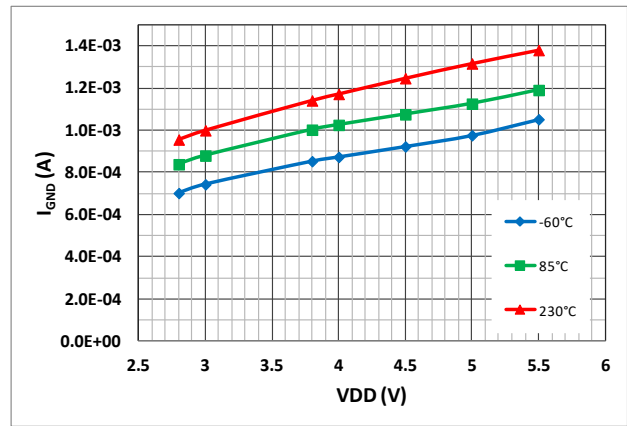

Figure 2. Ground current (I_{GND}) in full-power mode (LPMode=GND) vs. supply voltage (V_{DD}) for several case temperatures.

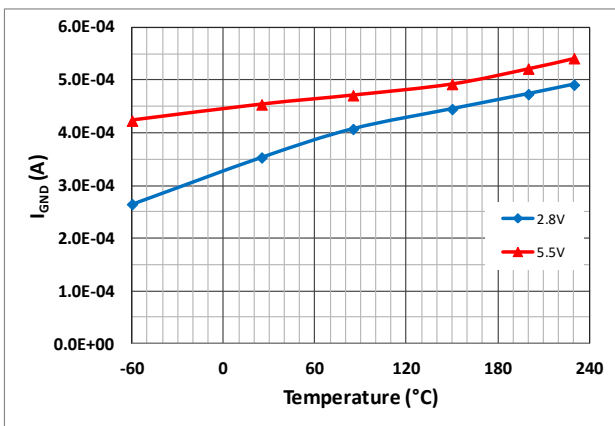

Figure 3. Ground current (I_{GND}) in low-power mode (LPMode=VDD) vs. case temperature for extreme supply voltages.

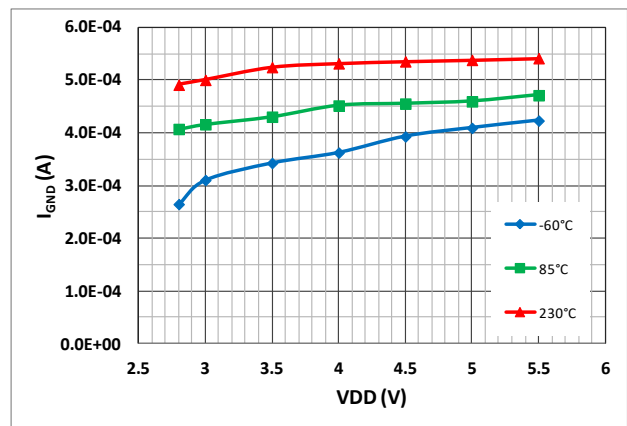

Figure 4. Ground current (I_{GND}) in low-power mode (LPMode=VDD) vs. supply voltage (V_{DD}) for several case temperatures.

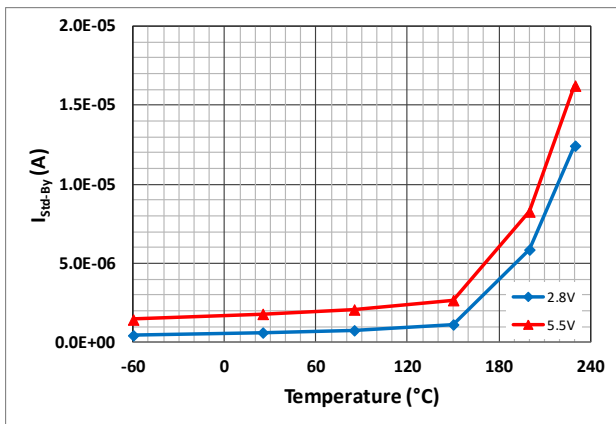

Figure 5. Stand-by current (I_{Std-By}) vs. case temperature for extreme supply voltages.

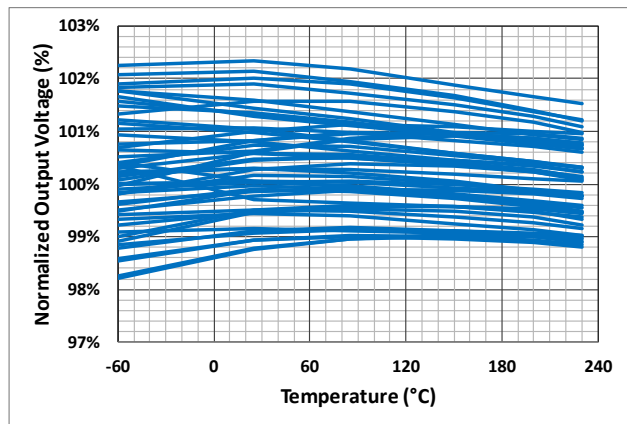

Figure 6. Normalized output voltage ($V_{OUT}/V_{OUT_Nominal}$) vs. case temperature for V_{DD} 2.8V and 5.5V and output voltages from 0.5V to 3.6V. 10 typical samples. $R_{LOAD}=1k\Omega$.

TYPICAL PERFORMANCE (CONTINUED)

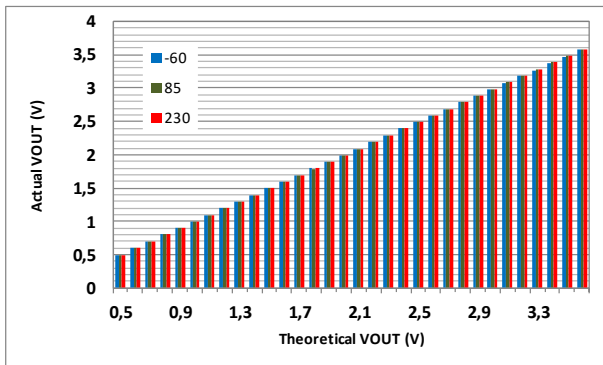

Figure 7. Actual measured output voltage (V_{OUT}) of the 32 internal preset values vs. nominal output voltage for different case temperatures. $V_{DD}=5.0V$.

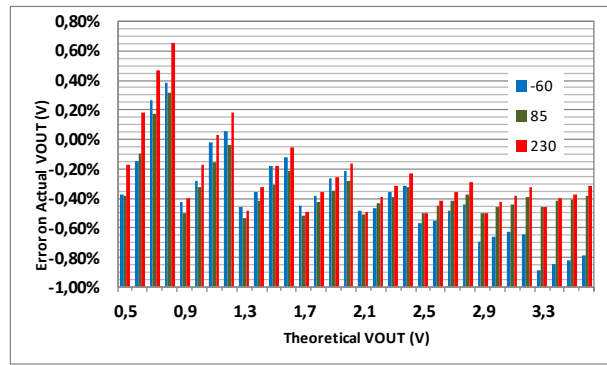

Figure 8. Accuracy of the actual measured output voltage of the 32 internal preset values vs. nominal output voltage for different case temperatures. $V_{DD}=5.0V$.

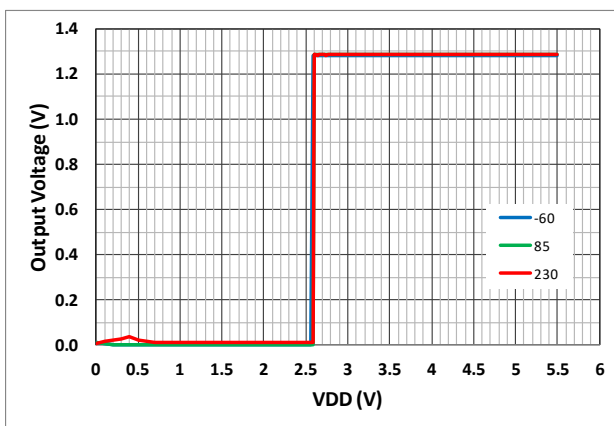

Figure 9. Output voltage (V_{OUT}) during start-up with V_{DD} swept from 0V to 5.5V for different case temperatures. $V_{OUT}=1.3V$, full-power mode (LPMode=GND), UVLO enabled.

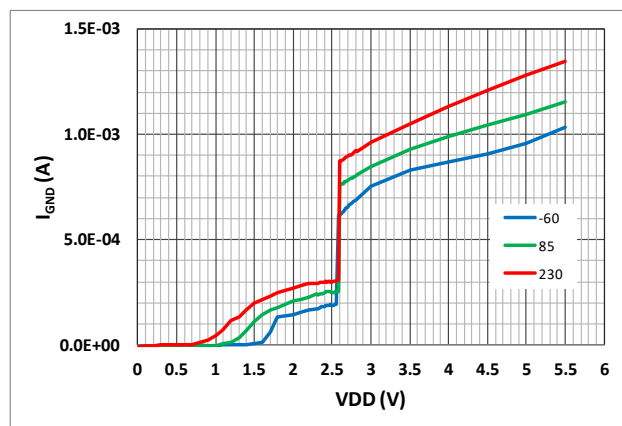

Figure 10. Ground current (I_{GND}) during start-up with V_{DD} swept from 0V to 5.5V for different case temperatures. $V_{OUT}=1.3V$, full-power mode (LPMode=GND), UVLO enabled.

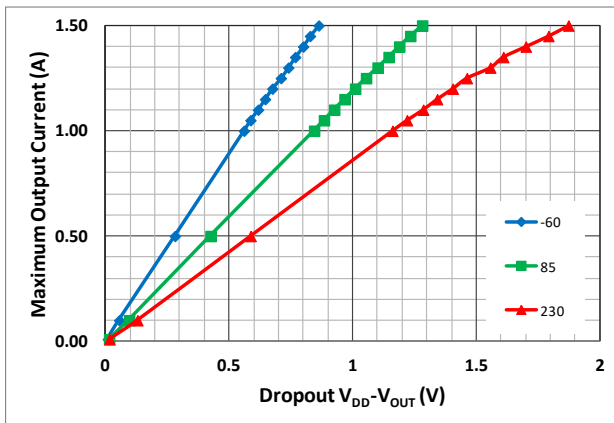

Figure 11. Maximum load current vs. dropout $V_{DD}-V_{OUT}$ and different case temperatures. $V_{OUT}=3.3V$, $V_{REF}=1.2V$.

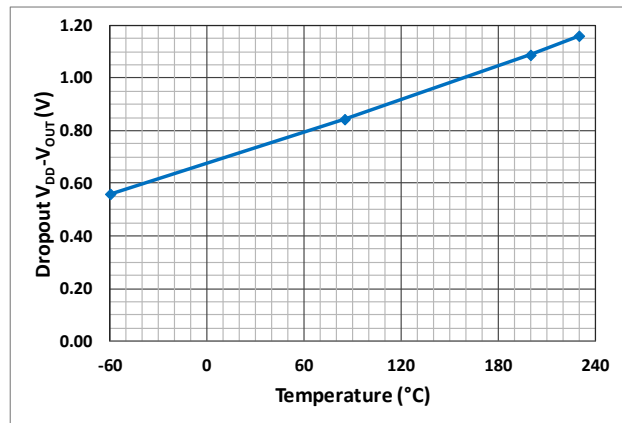

Figure 12. Dropout $V_{DD}-V_{OUT}$ load current for an output current of 1A vs. case temperature. $V_{OUT}=3.3V$, $V_{REF}=1.2V$.

TYPICAL PERFORMANCE (CONTINUED)

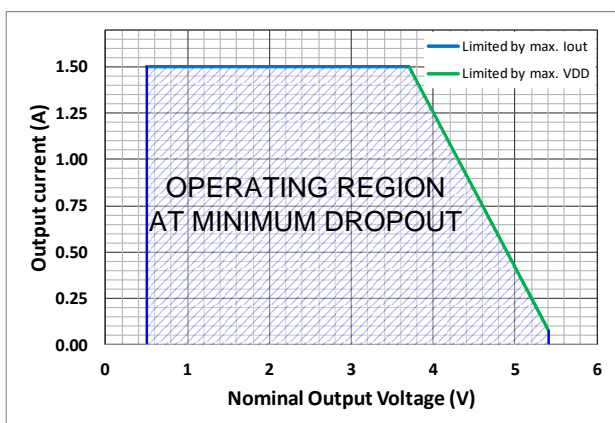

Figure 13. Operating region in terms of output current as a function of the nominal output voltage for $V_{DD}-V_{OUT} \geq \text{Min_Dropout}$. Worst case temperature ($T_c=230^\circ\text{C}$). $V_{DD_min}=2.8\text{V}$, $V_{DD_Max}=5.5\text{V}$.

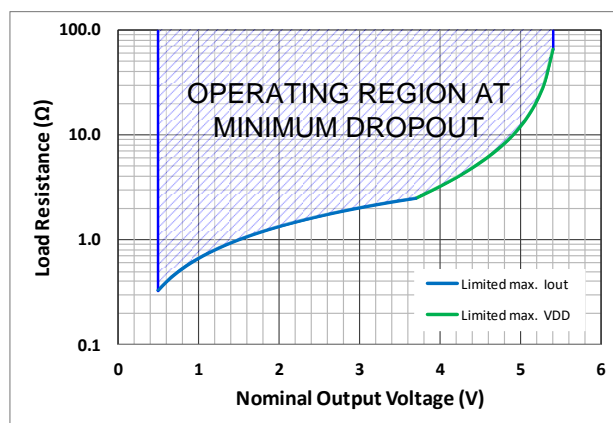

Figure 14. Operating region in terms of load resistance as a function of the nominal output voltage for $V_{DD}-V_{OUT} \geq \text{Min_Dropout}$. Worst case temperature ($T_c=230^\circ\text{C}$). $V_{DD_min}=2.8\text{V}$, $V_{DD_Max}=5.5\text{V}$.

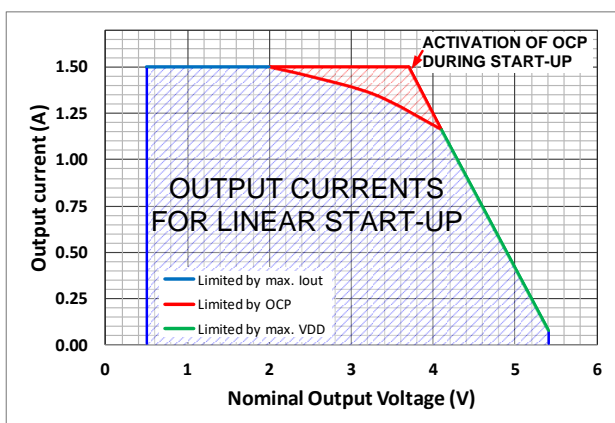

Figure 15. Allowed output currents during start-up without activation of the OCP as a function of the nominal output voltage for $V_{DD}-V_{OUT} \geq \text{Min_Dropout}$. Worst case temperature ($T_c=230^\circ\text{C}$). $V_{DD_min}=2.8\text{V}$, $V_{DD_Max}=5.5\text{V}$.

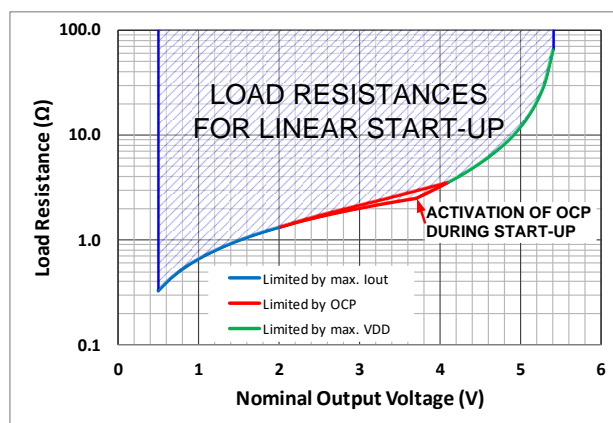

Figure 16. Allowed load resistances during start-up without activation of the OCP as a function of the nominal output voltage for $V_{DD}-V_{OUT} \geq \text{Min_Dropout}$. Worst case temperature ($T_c=230^\circ\text{C}$). $V_{DD_min}=2.8\text{V}$, $V_{DD_Max}=5.5\text{V}$.

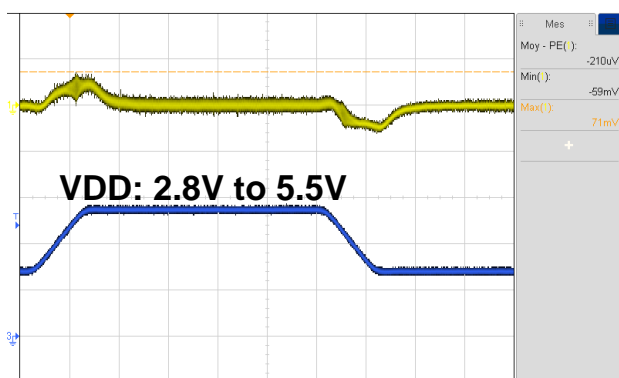

Figure 17. Transient response of the output voltage (YELLOW, 100mV/sq) to a fast variation of V_{DD} (BLUE, 2V/sq) from 2.8V to 5.5V in 100 μs . Maximum over/under shot of 71mV. $V_{OUT}=1.8\text{V}$, $C_{OUT}=1\mu\text{F}$, $R_{LOAD}=220\Omega$. Worst case temperature ($T_c=230^\circ\text{C}$). Time scale 100 μs /sq.

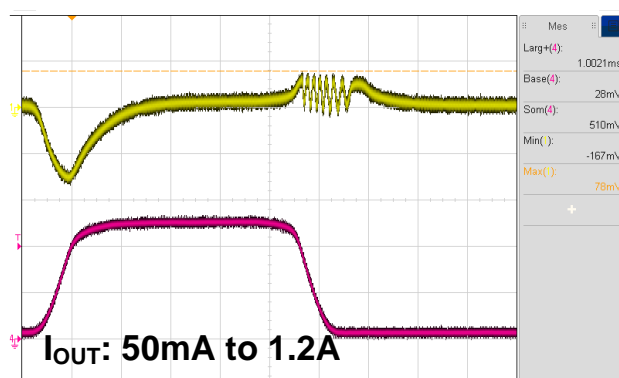

Figure 18. Transient response of the output voltage (YELLOW, 100mV/sq) to a fast variation of I_{OUT} (RED, 500mA/sq) from 50mA to 1.2A in 100 μs . Maximum over/under shot of 78mV/155mV. $V_{OUT}=1.8\text{V}$, $C_{OUT}=10\mu\text{F}$. Worst case temperature ($T_c=230^\circ\text{C}$). Time scale 100 μs /sq.

THEORY OF OPERATION

Introduction

The XTR70010 is a family of high-current, low-dropout (high-efficiency), low-voltage linear regulators. Due to the high current level (>1.5A) that can be handled by this LDO regulator, several protections have been implemented in order to avoid possible damage resulting from badly bypassed input networks, fast load transients, output short circuits, excessive self-heating or insufficient supply voltage.

In order to optimize the LDO dropout as well as the die size, the XTR70010 is based on an NMOS pass transistor, driven by a fully integrated charge pump.

The internal feedback loop has been optimized for stable operation on any capacitive load type ranging from 10nF up to 33µF. However, if the regulator is used for high current applications or in applications where the output current may present large steps (positives or negatives), a load capacitance of 1µF or more is recommended for softer output voltage transients.

Once VDD goes above the UVLO upper threshold and provided that the /SHDN input is HIGH, the LDO is activated. An internal soft start ramp is generated to ensure a smooth turn on. Thanks to this ramp, the output voltage will rise-up progressively, preventing possible inrush currents as well as any output overshoot.

A separate VOUTSNS pad is available for a precise sensing of the output voltage close to the load. This is particularly important at high current levels for ensuring a good load regulation. This sensing (Kelvin) pad can also be used for a fine tuning of the output voltage, using a resistive divider between VOUT, VOUTSNS and GND.

Basic Operation

In XTR70010 products, a given output voltage can be obtained using two different possible architectures.

In the minimum footprint architecture, the output voltage is directly determined by setting the internal reference to the desired output voltage. Using only input and output decoupling networks, no resistive divider is needed to set the output voltage. This architecture is shown in the following image.

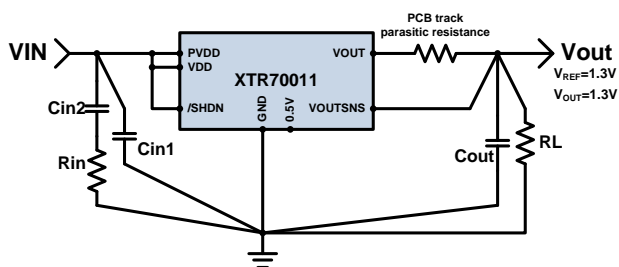

In the previous image, based on the packaged version XTR70011-FE, the internal reference is set to 1.3V. By connecting the VOUTSNS terminal (Kelvin feedback connection) to the output terminal VOUT, the output voltage V_{OUT} will also be 1.3V. This architecture needs, in all cases, an overhead ($V_{DD} - V_{REF}$) of 0.9V (typ).

Another way to obtain a given output voltage is to set a given reference voltage $V_{REF} < V_{OUT}$ and use a resistive divider between VOUT and VOUTSNS to set the necessary gain:

$$V_{OUT} = V_{REF} (1 + R_1/R_2)$$

The image below shows the typical application based on the XTR70011 and a resistive divider.

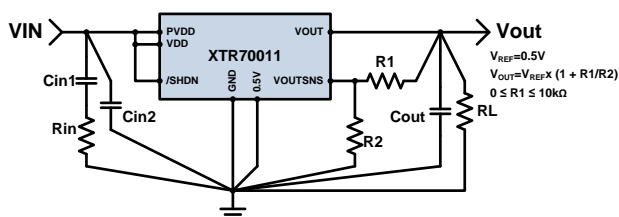

When setting the output voltage by means of a given V_{REF} and a resistive divider, the supply voltage V_{DD} must satisfy the following conditions

$$(V_{DD} - V_{REF}) > 0.9V$$

$$(V_{DD} - V_{OUT}) > \text{Min dropout for the given output current.}$$

When the feedback resistor R_1 is connected directly to the load to reduce the effects of PCB or substrate tracks parasitic resistance, an AC bypass capacitor C_1 (normally 1nF to 10nF) may be needed in parallel with R_1 . This will compensate for the parasitic capacitance between VOUTSNS and GND, keeping a stable loop gain at high frequency for improved transient performance.

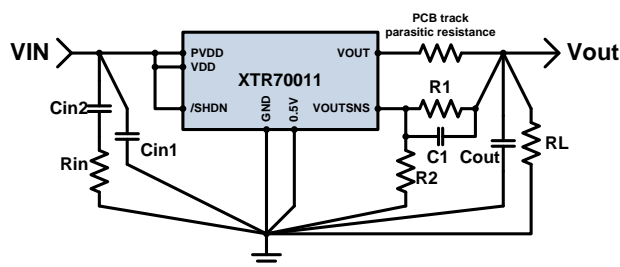

If fine tuning of V_{OUT} is required, it is recommended to adjust the internal V_{REF} level (with x.XV pads and BG0 / BG1 pads) a little bit below the expected V_{OUT} . Then, the R_1/R_2 ratio is adjusted to obtain the requested V_{OUT} .

Operation Modes

Full-power mode

Full-power mode is obtained by setting LPMODE to a LOW level. This can be done by leaving LPMODE pad floating or by connecting it to the GND potential.

When LPMODE is at LOW state, the internal charge pump is active and the pass transistor can provide output currents in excess of 1.5Amp with a dropout voltage of 1.9V (typ).

Low-power mode

It is possible to turn-off the internal charge pump by connecting LPMODE to V_{DD} . By doing so, the intrinsic current consumption of the XTR70010 part becomes significantly smaller than during full-power operation mode. However, in this state, the regulator cannot provide as much current as in the full-power mode described above. The minimum dropout in low-power mode will be comprised between 2V at -60°C and 1.3V at 230°C.

This low-power mode is mainly interesting if V_{DD} is high (>4V), V_{OUT} is low (<2V) and I_{LOAD} does not exceed few hundreds of mA.

Notice however that the LPMODE terminal can be driven "on-the-fly" during operation. This feature may result very useful when supplying a circuit that presents two distinct current consumption states, such as a microcontroller. Indeed, during normal operation, a microcontroller may present a quite high current consumption. However, in stand-by mode, the current consumption could be significantly decreased. In this case, the LPMODE terminal of the XTR70010 part can be driven so that the regulator is in full-power or low-power modes according to the needs of the microcontroller.

Functional Features and Protections

Power supply protection

In case of an overshoot on the input supply terminal VDD of about 0.5V with an equivalent frequency above 50kHz due to high parasitic inductance or low value input decoupling capacitors, the LDO will consider that there is an abnormal condition. In order to protect itself against any possible large swing oscillation of the input network, the LDO will turn off for 40ms before a new startup trial.

Under voltage lockout (UVLO)

To prevent the regulator to start-up with insufficient supply voltages, UVLO functionality with a small hysteresis is implemented (see the Electrical Specification table). Below the turn-on threshold, the internal oscillator and the LDO pass device are kept off. However, the part is not in stand-by mode.

Under voltage lockout functionality is active by default in the packaged versions XTR70011 and XTR70015 (/UVLOEnbl internally pulled down). When using bare dies of the XTR70010, UVLO functionality can be deactivated by setting /UVLOEnbl to HIGH (V_{DD}).

Over-current / short circuit protection (OCP)

XTR70010 devices have “hiccup” mode over current / short circuit protection.

When the short circuit protection threshold is reached, the LDO’s pass device is turned off progressively (soft shut-down) in order to avoid fast current variations in parasitic inductors. Once off, the regulator remains in this state for about 40ms before a new soft-start cycle is tried. If the short circuit condition is still present, the circuit will go again off and would try to soft restart, remaining in hiccup mode and presenting a low average DC current level until the short-circuit condition is no longer present.

The short-circuit protection functionality is active by default in the packaged versions XTR70011 and XTR70015 (/OCPEnbl internally pulled down). When using bare dies of the XTR70010, OCP functionality can be deactivated by setting /OCPEnbl to HIGH (V_{DD}).

If the OCP functionality is enabled (/TSEnbl = LOW), the current threshold at which this protection triggers can be selected among four possible values by setting pads OCP0 and OCP1 to HIGH or LOW.

OCP1	OCP0	OCP Threshold
LOW	LOW	1.9 Amp
LOW	HIGH	2.1 Amp
HIGH	LOW	1.7 Amp
HIGH	HIGH	1.5 Amp

Output overshoot remover

Overshoots on the output voltage may arise when a sudden decrease of the output current occurs due to a load being disconnected or going into stand-by mode (e.g. a microcontroller).

An internal block performs a continuous monitoring of the output sensing pin VOUTSNS. In case an overshoot reaches 60mV, the overshoot remover will promptly reduce the control voltage of the pass device in order to prevent the output voltage keeps increasing. The purpose is to protect the load against an abnormally high output voltage caused by the fast current transient.

Whenever the overshoot remover protection is activated, some ringing could be observed in the output terminal before coming back to the steady state (this depends on the load capacitance and on the di/dt that created the initial overshoot).

Thermal shut-down

XTR70010 devices have customer selectable thermal shutdown functionality. An internal circuitry is responsible for turning off the internal oscillator and the pass device when the junction temperature passes a predefined limit (see the Electrical Specification table). The system will automatically restart as soon as the junction temperature comes back below the lower hysteresis threshold of the thermal shutdown protection. This functionality is adjusted by bonding and can be disabled if required.

Thermal shutdown functionality is disabled by default in the packaged version XTR70011 (/TSEnbl internally pulled up) and enabled in the XTR70015 (/TSEnbl floating). When using bare dies of the XTR70010, the thermal shutdown functionality can be activated by setting /TSEnbl to LOW (GND) or by leaving this pad floating.

If the thermal shutdown is enabled (/TSEnbl = LOW), the temperature threshold at which this protection triggers can be chosen between two possible values by setting pad TSTh to HIGH or LOW.

TSTh	Thermal Shutdown Threshold
LOW	245 °C
HIGH	325 °C

Application Considerations

Input impedance quality factor

In applications with non-negligible parasitic inductance on the input supply line VDD, it is recommended to use two decoupling capacitors of 1 μ F in parallel, one of them with a small serial resistor (1 Ω to 5 Ω). Its purpose is to reduce the quality factor of the input parasitic LC circuit formed by the input wire inductor and C_{IN1} .

Thermal considerations

The XTR70010 has an internal thermal shutdown protection that can be activated or not by the final user when using bare dies. For the thermal shut-down configuration of XTR70011-FE and XTR70015-D, please refer to Internal Settings tables in the “Pin Description” section.

In all cases, the user must ensure that the junction temperature does not exceed the temperature indicated in the Absolute Maximum Ratings and remain within the recommended temperature range whenever possible. Functionality can be achieved even above 300°C at the expenses of reducing product lifetime. However, in the packaged versions provided by X-REL Semiconductor, it is not recommended to operate the parts above 250°C for long periods.

Ground connection

The XTR70010 ground pin should always be connected to the supply ground prior applying any input voltage. Accidental disconnecting of the ground terminal under operation could damage the part and its load. Make sure that during operation the GND pin represents the minimum potential seen by any pin of the XTR70010 part.

Start-up under heavy load conditions.

XTR70010 devices can operate at minimum dropout for the output currents described in Figure 13 as a function of the nominal voltages. The portion on the right delimited by the decreasing green line shows the limit due to the allowed maximum output voltage 5.5V and the needed dropout. Figure 14 shows the same information in terms of minimum load resistance.

However, during start-up and turn-off the device may see an insufficient dropout for the current being drawn from its output. The figure here below shows a region (delimited by a red line) for intermediate output voltages and high output currents for which XTR70010 devices activate the OCP during start-up and turn-off at temperatures above 180°C.

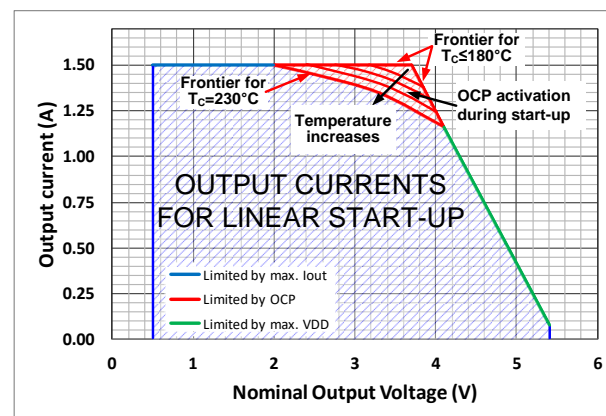

OCP activation during start-up and turn-off for the indicated temperatures, output voltages and output currents is depicted in the following figure.

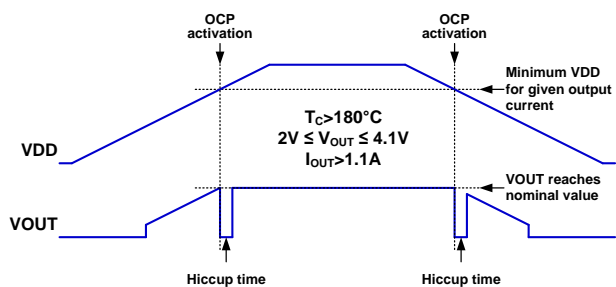

Regulator input shorting and input reversal

For a nominal output voltage $V_{\text{OUT}} \geq 2.5\text{V}$, connecting the input voltage to ground while the output capacitance is fully charged can create a large reverse current through the regulator pass element. If the load capacitance is large enough, the reverse current duration can be such that the regulator gets damaged.

Connecting the supply voltage in reverse polarity can damage the XTR70010. Take precautions when connecting the power supply lines. An external blocking diode can be added.

Current sinking capabilities

XTR70010 parts **are not able** to sink any current. Doing so would pull the output voltage above its nominal value and could damage the regulator and its load.

Testing on application boards

When testing the IC on an application board, connecting a capacitor to a pin while the XTR70010 is operating may subject the part to stress. Always discharge capacitors after each process or step. Always turn the power supply off before connecting or removing the XTR70010 from test fixture.

Ground the XTR70010 during assembly steps as an antistatic measure. Use similar precaution when transporting or storing the XTR70010.

PACKAGE OUTLINES

Dimensions shown in mm [inches]. Tolerances ± 0.13 mm [± 0.005 in] unless otherwise stated.

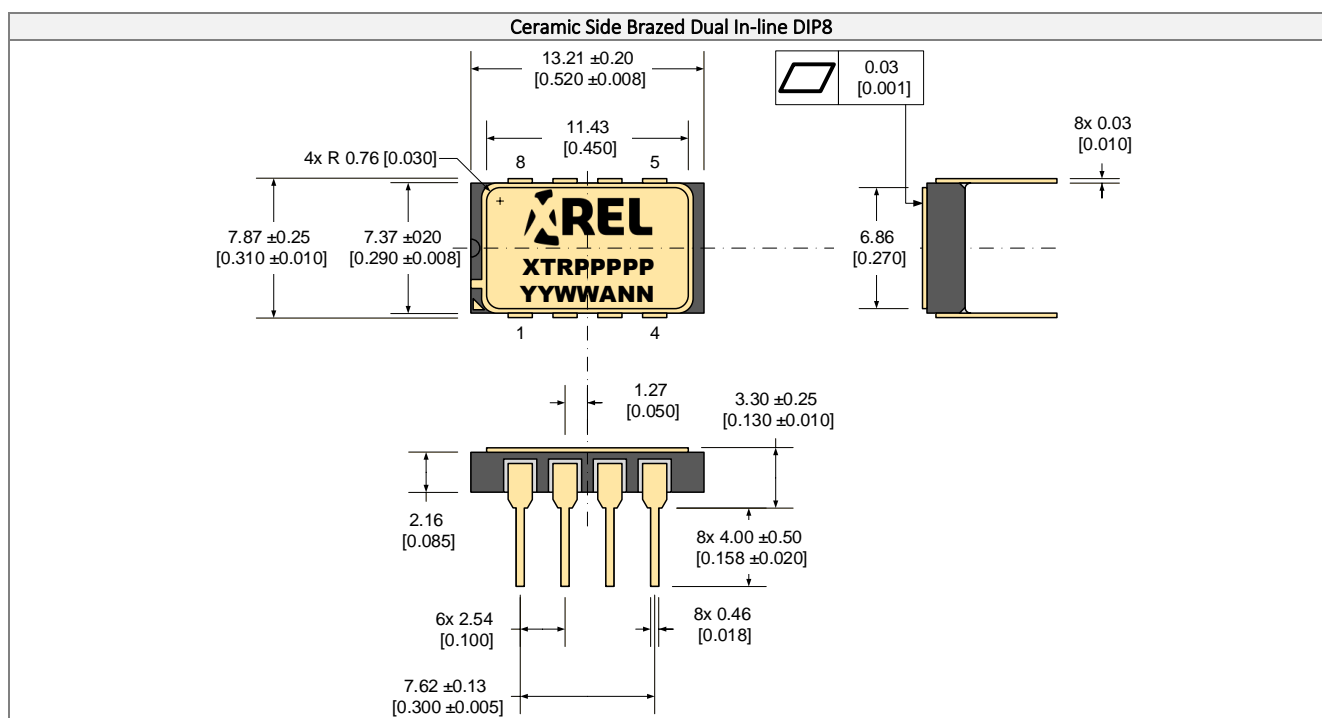
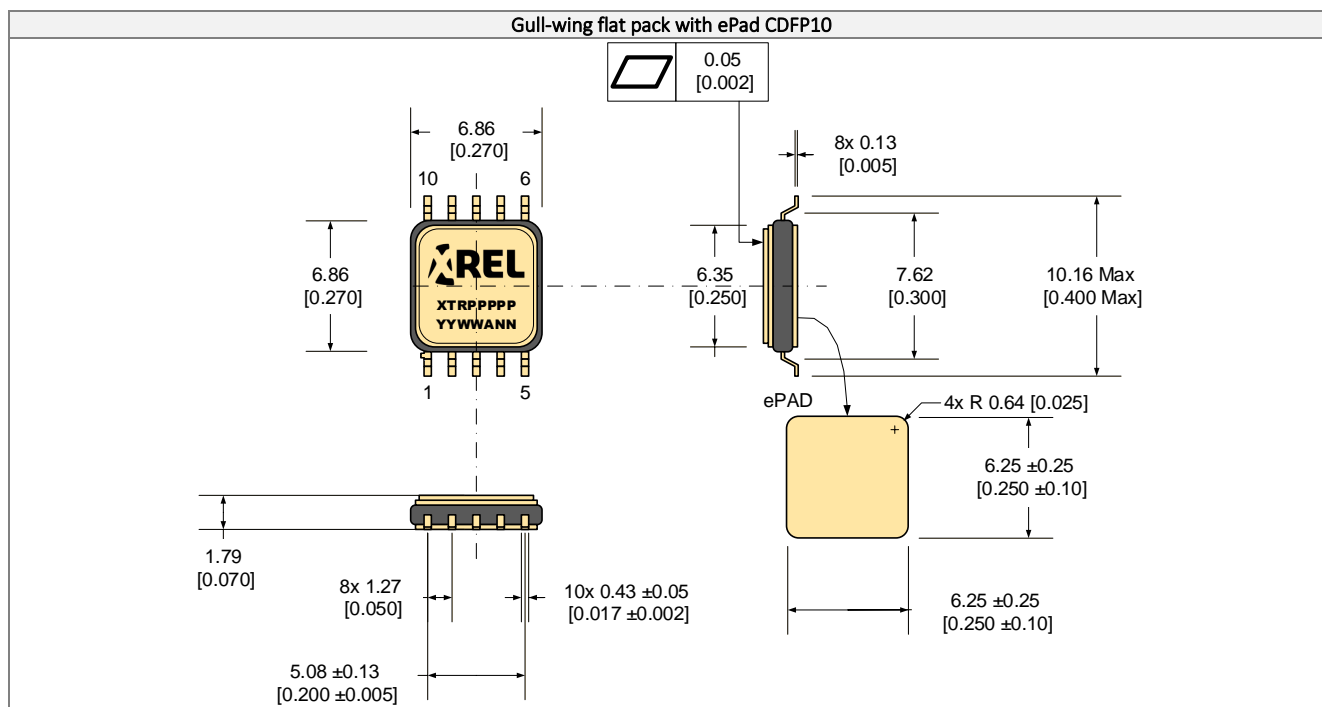

Part Marking Convention

Part Reference: XTRPPPPPP	
XTR	X-REL Semiconductor, high-temperature, high-reliability product (XTRM Series).
PPPPP	Part number (0-9, A-Z).
Unique Lot Assembly Code: YYWWANN	
YY	Two last digits of assembly year (e.g. 11 = 2011).
WW	Assembly week (01 to 52).
A	Assembly location code.
NN	Assembly lot code (01 to 99).

IMPORTANT NOTICE & DISCLAIMER

Information in this document supersedes and replaces all information previously supplied. Information in this document is provided solely in connection with EASii IC products from the X-REL business unit.

The information contained herein is believed to be reliable. EASii IC makes no warranties regarding the information contained herein. EASii IC assumes no responsibility or liability whatsoever for any of the information contained herein. EASii IC assumes no responsibility or liability whatsoever for the use of the information contained herein. The information contained herein is provided "AS IS, WHERE IS" and with all faults, and the entire risk associated with such information is entirely with the user. EASii IC reserves the right to make changes, corrections, modifications or improvements, to this document and the information herein without notice. Customers should obtain and verify the latest relevant information before placing orders for EASii IC products. The information contained herein or any use of such information does not grant, explicitly or implicitly, to any party any patent rights, licenses, or any other intellectual property rights, whether with regard to such information itself or anything described by such information.

Unless expressly approved in writing by an authorized representative of EASii IC, EASii IC products are not designed, authorized or warranted for use in military, aircraft, space, lifesaving, or life sustaining applications, nor in products or systems where failure or malfunction may result in personal injury, death, or property or environmental damage.

General Sales Terms & Conditions apply.

For product information and a complete list of distributors, please go to our web site: www.x-relsemi.com



90, Avenue Leon Blum 38100 Grenoble — France

☎ : +33 456 580 580

✉ : support.XREL@easii-ic.com

EASii IC, X-REL Semiconductor, and the logo are trademarks of EASii IC in France and other countries.

Data subject to change. Copyright © 2002-2021 EASii IC. All rights reserved.