



XTR2N0400

High Temperature, 40V N-Channel Power MOSFET

Rev 3 – August 2021 (DS-00101-11)

Data Sheet



PRODUCTION



CDIP8
XTR2N0425



TO257-3
XTR2N0425



FEATURES

- Minimum $BV_{DSS} = 55V$.
- Allowed V_{GS} range $-5.5V$ to $+5.5V$.
- Operational beyond the $-60^{\circ}C$ to $+230^{\circ}C$ temperature range.
- Low $R_{DS(on)}$
 - XTR2N0425: $560\ m\Omega$ @ $230^{\circ}C$
 - XTR2N0450: $255\ m\Omega$ @ $230^{\circ}C$
- Maximum I_b :
 - XTR2N0425: $4.7A$ @ $230^{\circ}C$
 - XTR2N0450: $10.3A$ @ $230^{\circ}C$
- On-time ($t_{d(on)}+t_r$):
 - XTR2N0425: $25nsec$ @ $230^{\circ}C$
 - XTR2N0450: $30nsec$ @ $230^{\circ}C$
- Off-time ($t_{d(off)}+t_f$):
 - XTR2N0425: $56nsec$ @ $230^{\circ}C$
 - XTR2N0450: $68nsec$ @ $230^{\circ}C$
- Ruggedized 3-lead TO257, 8-lead side brazed DIP and 8-lead SOIC with ePAD.
- Also available as bare die.

APPLICATIONS

- Reliability-critical, Automotive, Aeronautics & Aerospace, Down-hole.
- DC/DC converters, power switching, motor control, power inverters, power linear regulators, power supply.

DESCRIPTION

XTR2N0400 is a family of N-channel power MOSFETs designed to reliably operate over a wide range of temperatures. Full functionality is guaranteed from $-60^{\circ}C$ to $+230^{\circ}C$, though operation well below and above this temperature range is achieved.

Fabricated on a Silicon-on-Insulator (SOI) process, XTR2N0400 family parts offer reduced leakage currents while providing high drain currents a low $R_{DS(on)}$. These features allow XTR2N0400 parts to be ideally suited for switching applications.

XTR2N0400 family parts have been designed to reduce system cost and ease adoption by reducing the learning curve and providing smart and easy to use features.

Parts from the XTR2N0400 family are available in ruggedized 3-lead TO257, 8-lead side brazed DIP. Parts are also available as tested bare die.

PRODUCT HIGHLIGHT

Power Series Regulator

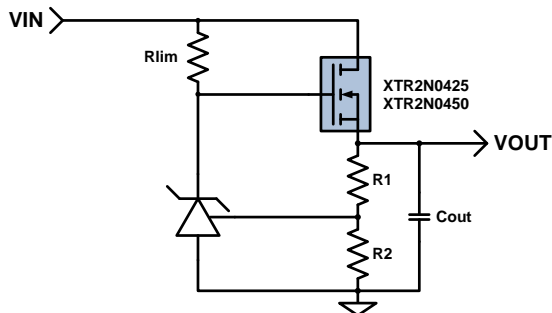

Step-down DC-DC Converter

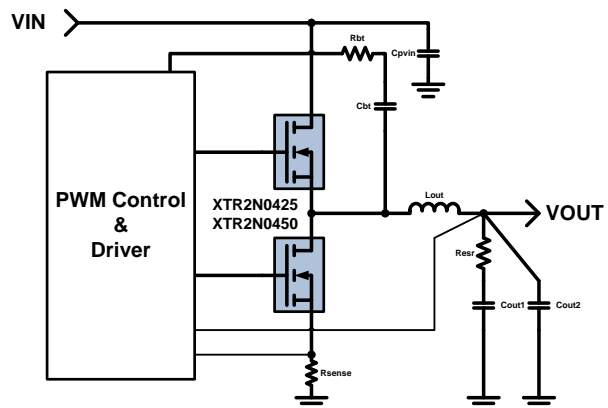

ORDERING INFORMATION

X
↓
Source :
X = X-REL Semi

TR
↓
Process:
TR = HiTemp, HiRel

2N
↓
Part family

04xx
↓
Part number

| Product Reference | Temperature Range | Package | Pin Count | Marking |
|-------------------|-------------------|-------------------------|-----------|-----------|
| XTR2N0425-TD | -60°C to +230°C | Tested bare die | | |
| XTR2N0425-D | -60°C to +230°C | Ceramic side brazed DIP | 8 | XTR2N0425 |
| XTR2N0425-T | -60°C to +230°C | TO257 | 3 | XTR2N0425 |
| XTR2N0450-TD | -60°C to +230°C | Tested bare die | | |

Other packages and packaging configurations possible upon request. For some packages or packaging configurations, MOQ may apply.

ABSOLUTE MAXIMUM RATINGS

| | |
|--------------------------------------|---------------------|
| Drain-source voltage | -2V to 55V |
| Gate-source voltage | ±6.0V |
| Storage temperature range | -70°C to +230°C |
| Operating junction temperature range | -70°C to +300°C |
| ESD classification | 2kV HBM MIL-STD-750 |

Caution: Stresses beyond those listed in "ABSOLUTE MAXIMUM RATINGS" may cause permanent damage to the device. These are stress ratings only and functionality of the device at these or any other condition beyond those indicated in the operational sections of the specifications is not implied. Exposure to "ABSOLUTE MAXIMUM RATINGS" conditions for extended periods may permanently affect device reliability.

PRODUCT VARIANTS

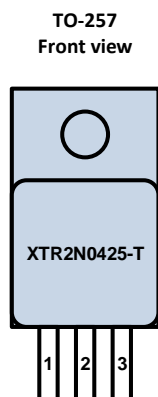

1 DRAIN
2 SOURCE
3 GATE

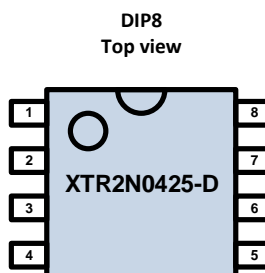

1, 2, 3 SOURCE
4 GATE
5, 6, 7, 8 DRAIN

THERMAL CHARACTERISTICS

| Parameter | Condition | Min | Typ | Max | Units |
|--|------------|-----|-----|-----|-------|
| XTR2N0425-T (TO257) | | | | | |
| Thermal Resistance: J-C R_{th_j-c} | | | 5 | | °C/W |
| Thermal Resistance: J-A R_{th_j-a} | Still air. | | 50 | | °C/W |
| XTR2N0425-D (DIP8) | | | | | |
| Thermal Resistance: J-C R_{th_j-c} | | | 20 | | °C/W |
| Thermal Resistance: J-A R_{th_j-a} | Still air. | | 100 | | °C/W |

RECOMMENDED OPERATING CONDITIONS

| Parameter | Min | Typ | Max | Units |
|---|------|-----|------|-------|
| Drain-source voltage V_{DS} | -1.5 | | 40 | V |
| Gate-source voltage V_{GS} | -5.5 | | +5.5 | V |
| Junction Temperature ¹ T_J | -60 | | 230 | °C |

¹ Operation beyond the specified temperature range is achieved. The -60°C to +230°C range for the case temperature is considered for the case where $I_{D(DC)}$ for a given case temperature.

XTR2N0425 SPECIFICATIONS

Unless otherwise stated, specification applies for -60°C < T_J < 230°C.

| Parameter | Condition | Min | Typ | Max | Units |
|--|--|----------------------|----------------------|-------------------|-------|
| DC Characteristics | | | | | |
| Drain-source breakdown voltage BV_{DSS} | V _{GS} =0V, I _{DS} =100μA | 55 | | | V |
| Static drain-source on-state resistance R_{DS(on)} | V _{GS} =+5V, I _{DS} =100mA T _C =-60°C T _C =85°C T _C =230°C | | 230 360 560 | 280 430 670 | mΩ |
| Continuous drain current I_{D(DC)} | V _{GS} =+5V for TO-257 T _J =-60°C T _J =85°C T _J =230°C | 1.75 1.25 0.95 | 2.2 1.6 1.2 | | A |
| Gate threshold voltage V_{GS(th)} | V _{DS} =V _{GS} , I _{DS} =1mA T _C =-60°C T _C =85°C T _C =230°C | | 1.76 1.38 0.89 | | V |
| Temperature drift of gate threshold voltage ΔV_{GS(th)}/ΔT_J | V _{DS} =V _{GS} , I _{DS} =1mA | | -3.0 | | mV/°C |
| Off-state drain current I_{DSS} | V _{DS} =40V, V _{GS} =0V T _C =85°C T _C =230°C | | 0.01 13 | 0.5 60 | μA |
| Gate Leakage current I_{GSS} | V _{GS} =±5V, V _{DS} =0V T _C =85°C T _C =230°C | | ±0.6 ±130 | ±5 ±1000 | nA |
| AC Characteristics | | | | | |
| Input capacitance C_{iss} | V _{DS} =32V, V _{GS} =0V, f=1MHz | | 390 | | pF |
| Output capacitance C_{oss} | | | 80 | | pF |
| Transfer capacitance C_{rss} | | | 65 | | pF |
| Switching Characteristics | | | | | |
| Pulsed drain current I_{DM} | V _{DS} =20V, V _{GS sweep} =0 to +5V, d=0.2%, □=1ms T _C =-60°C T _C =85°C T _C =230°C | 7.0 5.0 3.8 | 8.8 6.2 4.7 | | A |
| Total gate charge Q_g | V _{DS} =20V, V _{GS sweep} =0 to +5V | | 5.4 | | nC |
| Turn-on delay time t_{d(on)} | V _{DS} =20V, V _{GS sweep} =0 to +5V, R _D =47Ω, d=0.2%, □=1ms | | 11 | | ns |
| Rise time t_r | V _{DS} =20V, V _{GS sweep} =0 to +5V, R _D =47Ω, d=0.2%, □=1ms | | 14 | | |
| Turn-off delay time t_{d(off)} | V _{DS} =20V, V _{GS sweep} =0 to +5V, R _D =47Ω, d=0.2%, □=1ms | | 29 | | |
| Fall time t_f | V _{DS} =20V, V _{GS sweep} =0 to +5V, R _D =47Ω, d=0.2%, □=1ms | | 27 | | |
| Drain-Source Diode Characteristics | | | | | |
| Forward diode voltage V_{SD,1A} | V _{GS} =0V, I _{DS} =-1A T _C =-60°C T _C =85°C T _C =230°C | | 1.10 0.97 0.89 | | V |

XTR2N0450 SPECIFICATIONS

Unless otherwise stated, specification applies for $-60^{\circ}\text{C} < T_J < 230^{\circ}\text{C}$.

| Parameter | Condition | Min | Typ | Max | Units |
|---|--|---------------------|------------------------|-----------------------|-----------------------|
| DC Characteristics | | | | | |
| Drain-source breakdown voltage BV_{DSS} | $V_{GS}=0V, I_{DS}=100\mu A$ | 55 | | | V |
| Static drain-source on-state resistance $R_{DS(on)}$ | $V_{GS}=+5V, I_{DS}=100mA$ $T_C=-60^{\circ}\text{C}$ $T_C=85^{\circ}\text{C}$ $T_C=230^{\circ}\text{C}$ | | 105 165 255 | 130 200 310 | $m\Omega$ |
| Continuous drain current $I_{D(C)}$ | $V_{GS}=+5V$ for TO-257 $T_J=-60^{\circ}\text{C}$ $T_J=85^{\circ}\text{C}$ $T_J=230^{\circ}\text{C}$ | 3.8 2.7 2.1 | 4.8 3.4 2.6 | | A |
| Gate threshold voltage $V_{GS(th)}$ | $V_{DS}=V_{GS}, I_{DS}=1mA$ $T_C=-60^{\circ}\text{C}$ $T_C=85^{\circ}\text{C}$ $T_C=230^{\circ}\text{C}$ | | 1.72 1.32 0.79 | | V |
| Temperature drift of gate threshold voltage $\Delta V_{GS(th)}/\Delta T_J$ | $V_{DS}=V_{GS}, I_{DS}=1mA$ | | -3.2 | | $mV/^{\circ}\text{C}$ |
| Off-state drain current I_{DSS} | $V_{DS}=40V, V_{GS}=0V$ $T_C=85^{\circ}\text{C}$ $T_C=230^{\circ}\text{C}$ | | 0.02 30 | 1 150 | μA |
| Gate Leakage current I_{GSS} | $V_{GS}=\pm 5V, V_{DS}=0V$ $T_C=85^{\circ}\text{C}$ $T_C=230^{\circ}\text{C}$ | | ± 0.8 ± 160 | ± 5 ± 1000 | nA |
| AC Characteristics | | | | | |
| Input capacitance C_{iss} | $V_{DS}=32V, V_{GS}=0V, f=1MHz$ | | 900 | | pF |
| Output capacitance C_{oss} | | | 180 | | pF |
| Transfer capacitance C_{rss} | | | 150 | | pF |
| Switching Characteristics | | | | | |
| Pulsed drain current I_{DM} | $V_{DS}=20V, V_{GS\ sweep}=0$ to +5V, $d=0.2\%$, $\tau=1ms$ $T_C=-60^{\circ}\text{C}$ $T_C=85^{\circ}\text{C}$ $T_C=230^{\circ}\text{C}$ | 15.5 10.9 8.3 | 19.4 13.6 10.3 | | A |
| Total gate charge Q_g | $V_{DS}=20V, V_{GS\ sweep}=0$ to +5V | | 12.2 | | nC |
| Turn-on delay time $t_{d(on)}$ | $V_{DS}=20V, V_{GS\ sweep}=0$ to +5V, $R_D=47\Omega, d=0.2\%$, $\tau=1ms$ | | 13 | | ns |
| Rise time t_r | $V_{DS}=20V, V_{GS\ sweep}=0$ to +5V, $R_D=47\Omega, d=0.2\%$, $\tau=1ms$ | | 17 | | |
| Turn-off delay time $t_{d(off)}$ | $V_{DS}=20V, V_{GS\ sweep}=0$ to +5V, $R_D=47\Omega, d=0.2\%$, $\tau=1ms$ | | 35 | | |
| Fall time t_f | $V_{DS}=20V, V_{GS\ sweep}=0$ to +5V, $R_D=47\Omega, d=0.2\%$, $\tau=1ms$ | | 33 | | |
| Drain-Source Diode Characteristics | | | | | |
| Forward diode voltage $V_{SD,1A}$ | $V_{GS}=0V, I_{DS}=-1A$ $T_C=-60^{\circ}\text{C}$ $T_C=85^{\circ}\text{C}$ $T_C=230^{\circ}\text{C}$ | | 1.00 0.88 0.66 | | V |

XTR2N0425 TYPICAL PERFORMANCE

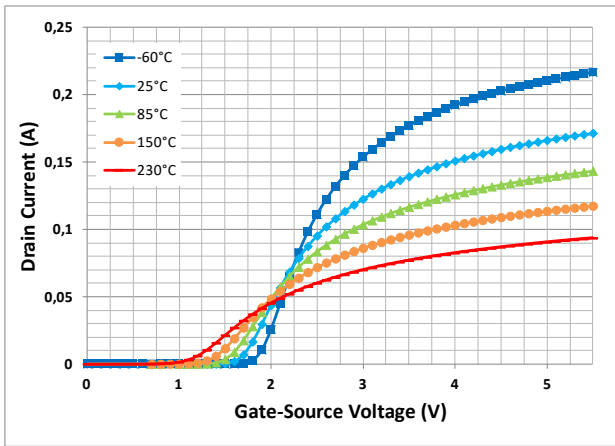

Figure 1. Drain Current (I_{DS}) vs Gate-Source Voltage for several case temperatures. $V_{DS}=50mV$.

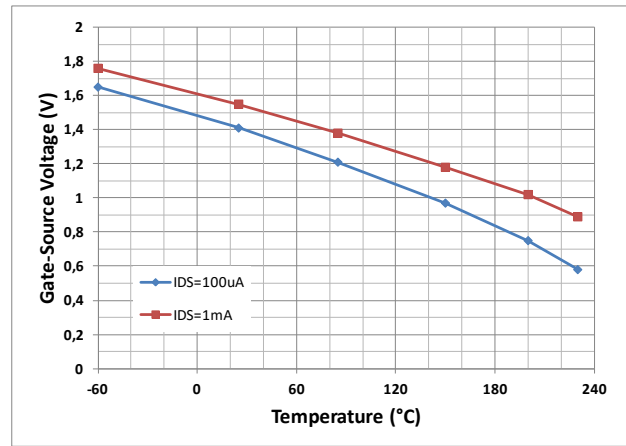

Figure 2. Gate-Source Threshold Voltage ($V_{GS(th)}$) vs Gate-Source Voltage for several case temperatures. $V_{GS}=V_{DS}$.

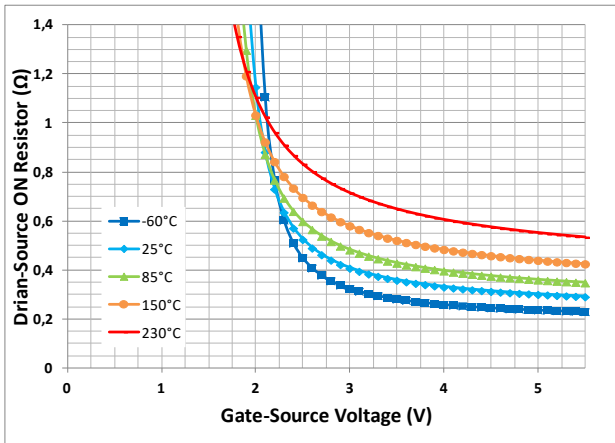

Figure 3. Drain-Source ON Resistance ($R_{DS(on)}$) vs Gate-Source Voltage for several case temperatures. $V_{DS}=50mV$.

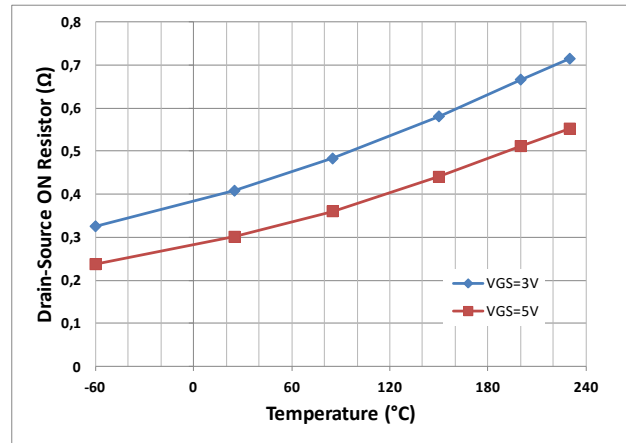

Figure 4. Drain-Source ON Resistance ($R_{DS(on)}$) vs Case Temperature. $V_{DS}=50mV$.

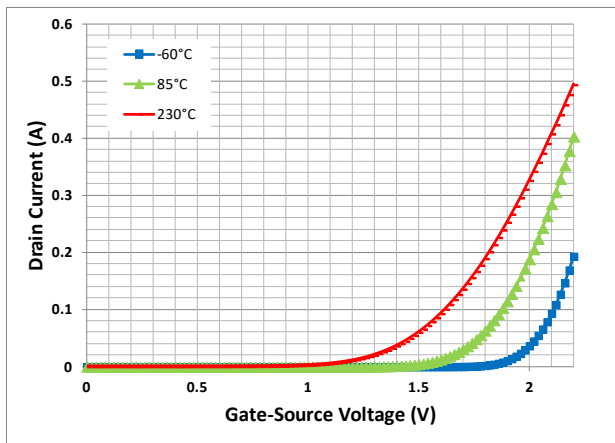

Figure 5. Drain Current (I_{DS}) vs Gate-Source Voltage for several case temperatures. $V_{GS}=V_{DS}$

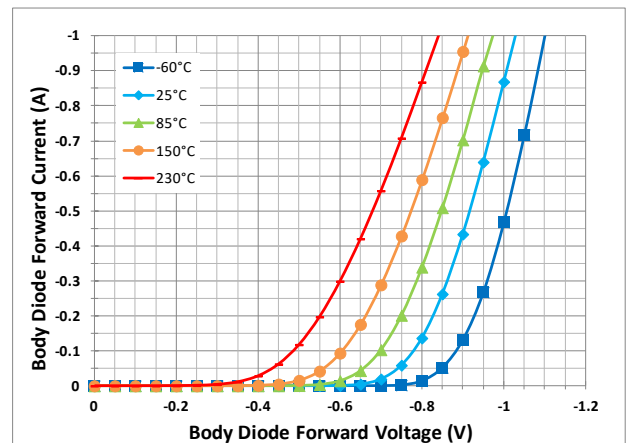

Figure 6. Body Diode Forward Current (I_{FB}) vs Forward Voltage for several case temperature. $V_{GS}=0V$.

XTR2N0325 TYPICAL PERFORMANCE (CONTINUED)

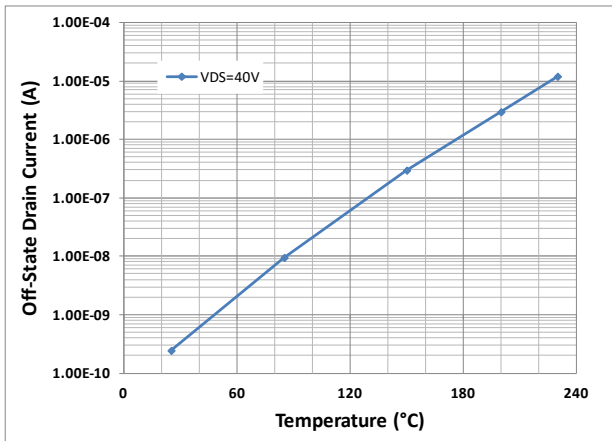

Figure 7. Off-State Drain Current (I_{oss}) vs Case Temperature. $V_{DS}=40V$, $V_{GS}=0V$.

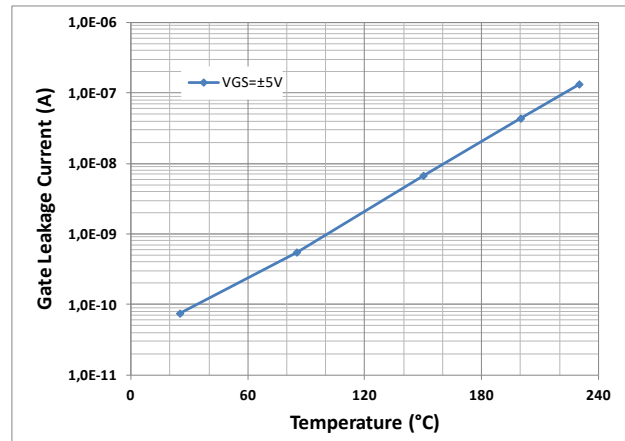

Figure 8. Gate Leakage Current (I_{gss}) vs Case Temperature. $V_{GS}=\pm 5V$, $V_{DS}=0V$.

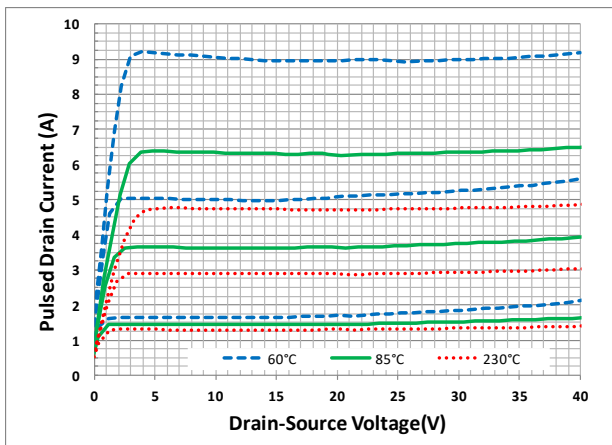

Figure 9. Pulsed Drain Current (I_{DM}) vs Drain-Source Voltage for several case temperatures. $V_{GS}=3V, 4V$ and $5V$.

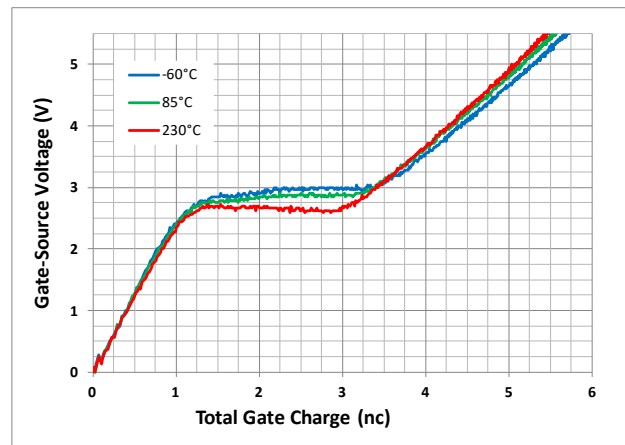

Figure 10. Total Gate Charge (Q_g) vs Gate-Source Voltage for several case temperatures. $I_{DS}=900mA$.

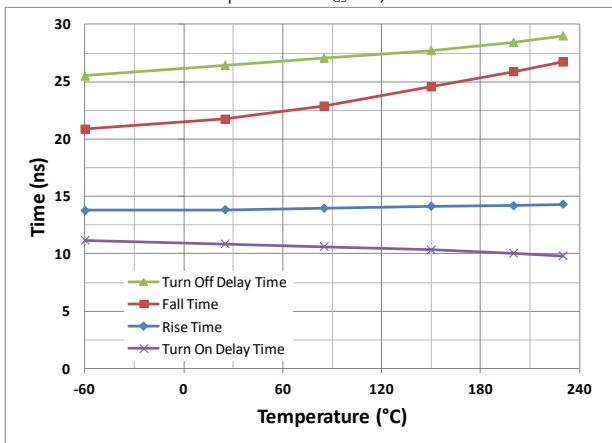

Figure 11. Timing Characteristics vs Case Temperature. $V_{DS}=20V$, V_{GS} sweep= 0 to 5V.

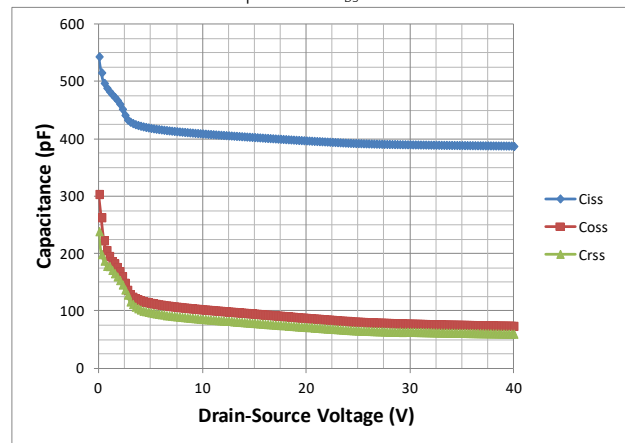

Figure 12. Capacitance vs Drain-Source Voltage at $T_c=25^\circ C$.

XTR2N0450 TYPICAL PERFORMANCE

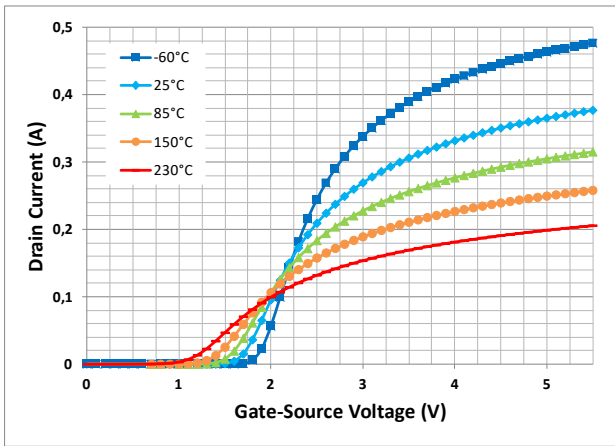

Figure 13. Drain Current (I_{DS}) vs Gate-Source Voltage for several case temperatures. $V_{DS}=50mV$.

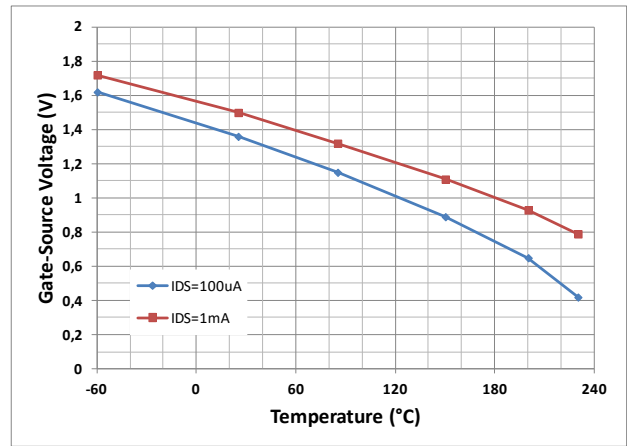

Figure 14. Gate-Source Threshold Voltage ($V_{GS(th)}$) vs Case Temperature. $V_{GS}=V_{DS}$.

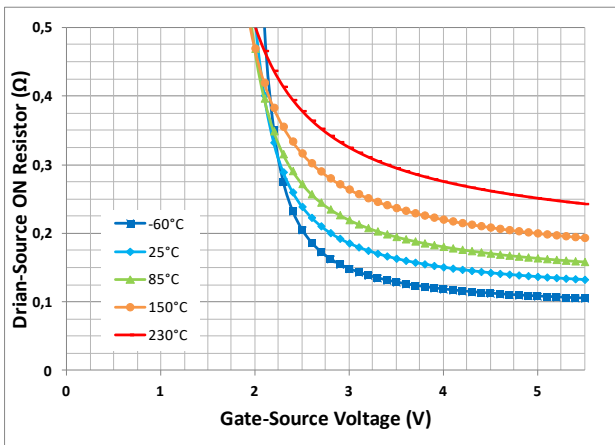

Figure 15. Drain-Source ON Resistance ($R_{DS(on)}$) vs Gate-Source Voltage for several case temperatures. $V_{DS}=50mV$.

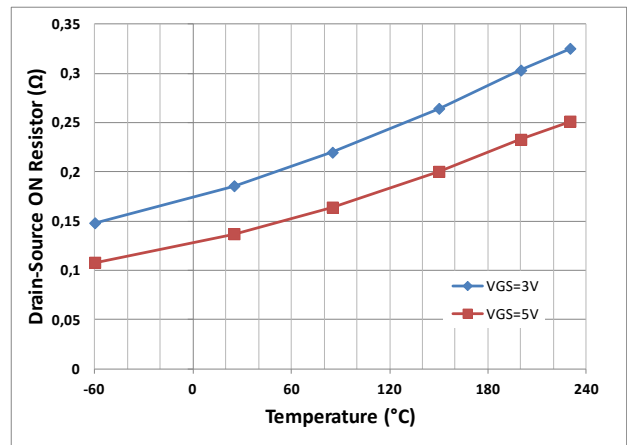

Figure 16. Drain-Source ON Resistance ($R_{DS(on)}$) vs Case Temperature. $V_{DS}=50mV$.

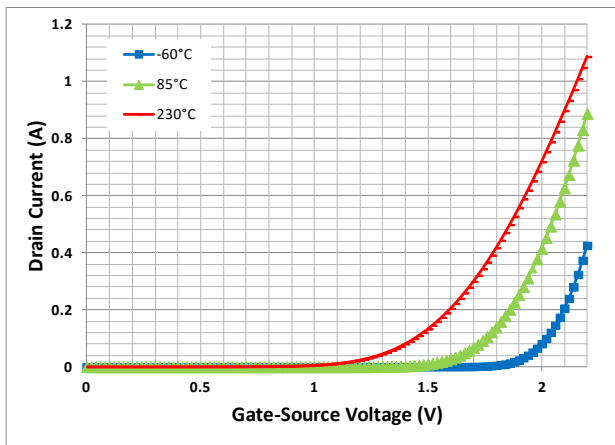

Figure 17. Drain Current (I_{DS}) vs Gate-Source Voltage for several case temperatures. $V_{GS}=V_{DS}$

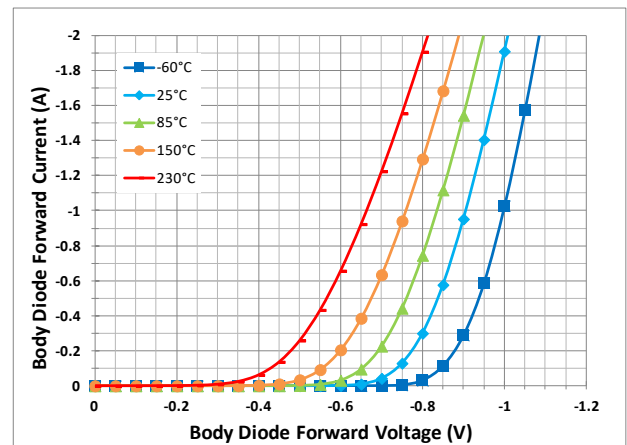

Figure 18. Body Diode Forward Current (I_{FD}) vs Forward Voltage for several case temperature. $V_{GS}=0V$.

XTR2N0450 TYPICAL PERFORMANCE (CONTINUED)

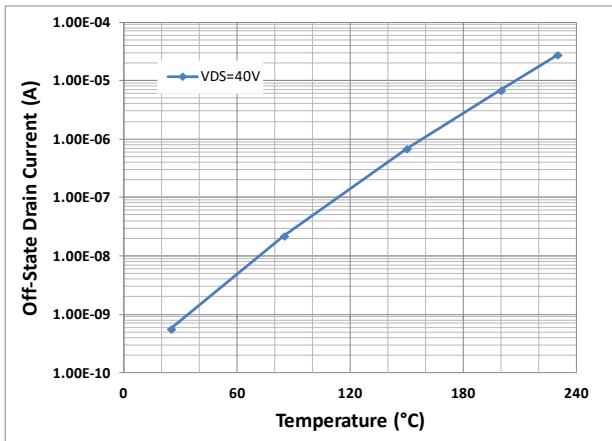

Figure 19. Off-State Drain Current (I_{DSS}) vs Case Temperature. $V_{DS}=40V$, $V_{GS}=0V$.

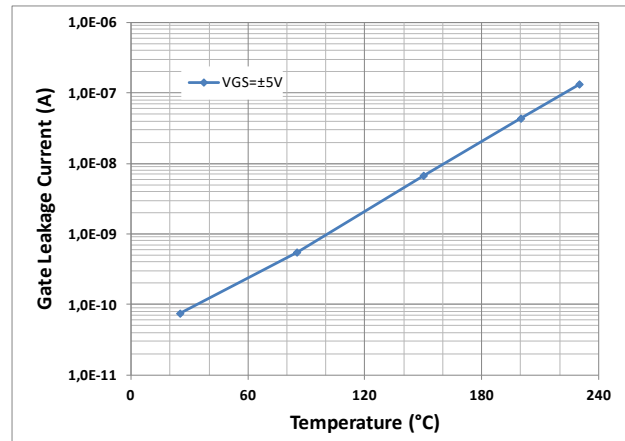

Figure 20. Gate Leakage Current (I_{GSS}) vs Case Temperature. $V_{GS}=\pm 5V$, $V_{DS}=0V$.

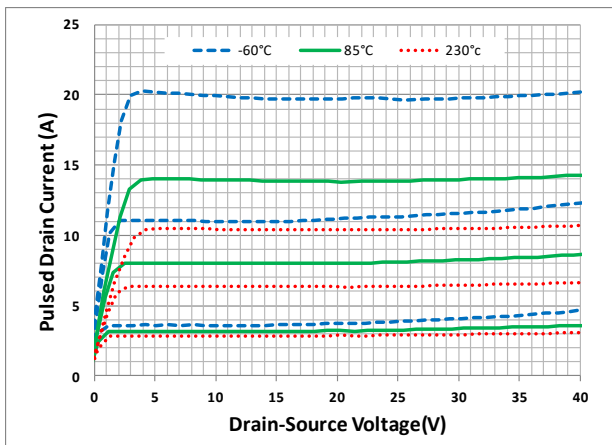

Figure 21. Pulsed Drain Current (I_{DM}) vs Drain-Source Voltage for several case temperatures. $V_{GS}=3V, 4V$ and $5V$.

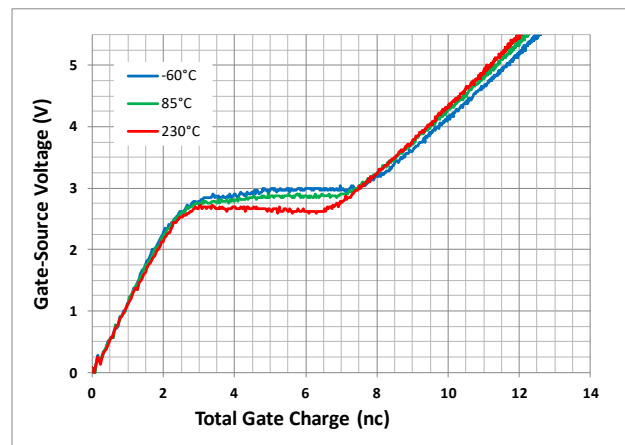

Figure 22. Total Gate Charge (Q_g) vs Gate-Source Voltage for several case temperatures. $I_{DS}=900mA$.

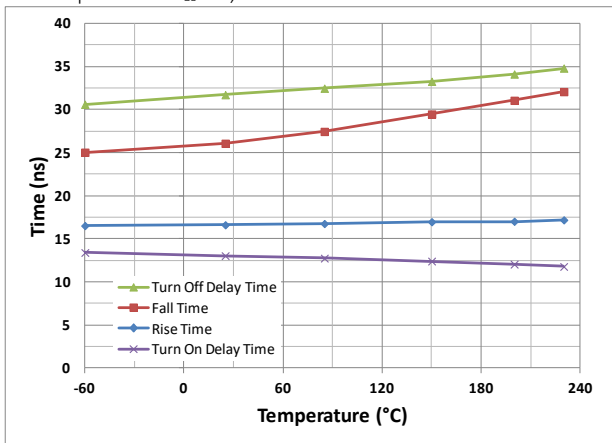

Figure 23. Timing Characteristics vs Case Temperature. $V_{DS}=20V$, V_{GS} sweep= 0 to 5V.

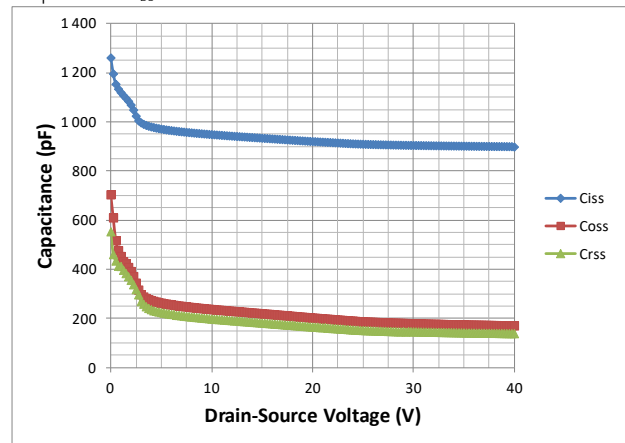

Figure 24. Capacitance vs Drain-Source Voltage at $T_c=25^\circ C$.

PARAMETER DEFINITION

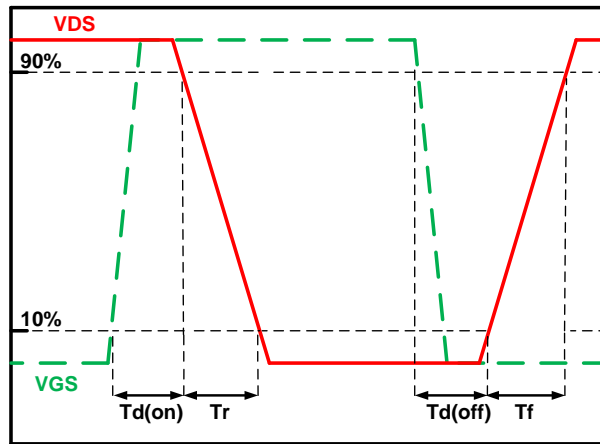
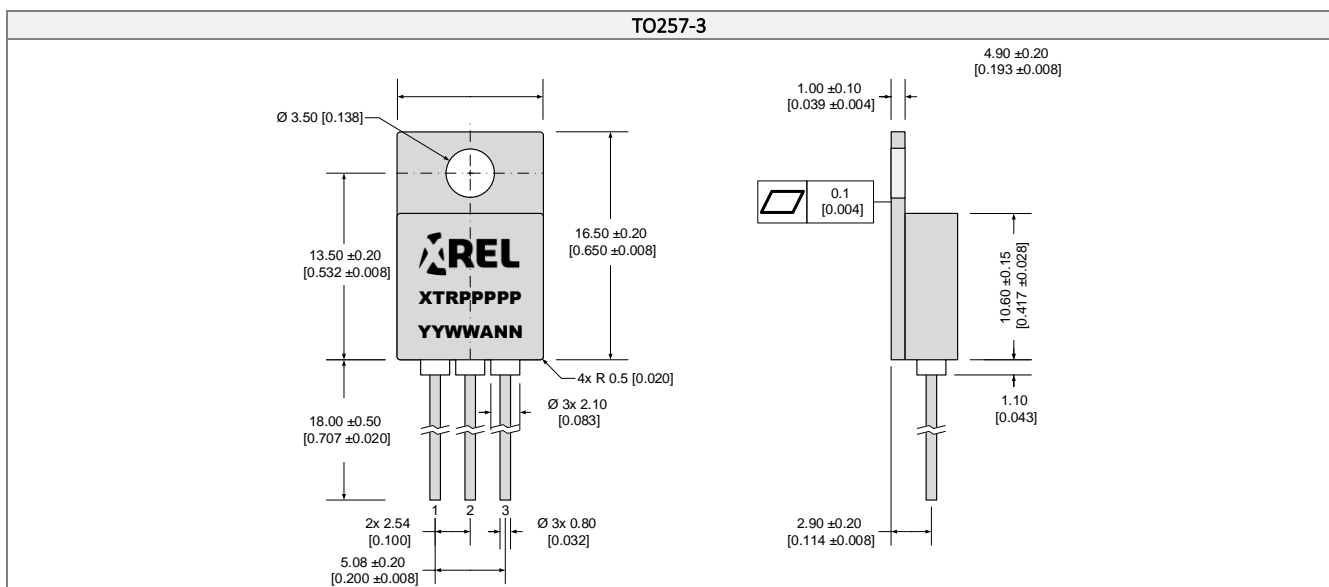
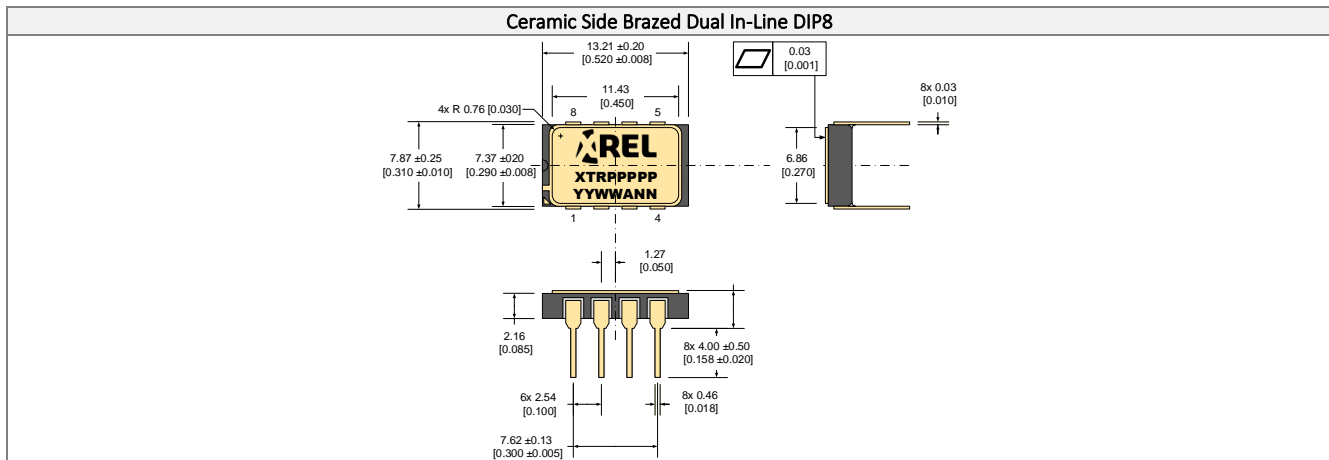

Figure 25. Timing diagram definition.

PACKAGE OUTLINES

Dimensions shown in mm [inches]. Tolerances ± 0.13 mm [± 0.005 in] unless otherwise stated.



Part Marking Convention

Part Reference: XTRPPPPP

XTR X-REL Semiconductor, high-temperature, high-reliability product (XTRM Series).

PPPPP Part number (0-9, A-Z).

Unique Lot Assembly Code: YYWANN

YY Two last digits of assembly year (e.g. 11 = 2011).

WW Assembly week (01 to 52).

A Assembly location code.

NN Assembly lot code (01 to 99).

IMPORTANT NOTICE & DISCLAIMER

Information in this document supersedes and replaces all information previously supplied. Information in this document is provided solely in connection with EASii IC products from the X-REL business unit.

The information contained herein is believed to be reliable. EASii IC makes no warranties regarding the information contained herein. EASii IC assumes no responsibility or liability whatsoever for any of the information contained herein. EASii IC assumes no responsibility or liability whatsoever for the use of the information contained herein. The information contained herein is provided "AS IS, WHERE IS" and with all faults, and the entire risk associated with such information is entirely with the user. EASii IC reserves the right to make changes, corrections, modifications or improvements, to this document and the information herein without notice. Customers should obtain and verify the latest relevant information before placing orders for EASii IC products. The information contained herein or any use of such information does not grant, explicitly or implicitly, to any party any patent rights, licenses, or any other intellectual property rights, whether with regard to such information itself or anything described by such information.

Unless expressly approved in writing by an authorized representative of EASii IC, EASii IC products are not designed, authorized or warranted for use in military, aircraft, space, lifesaving, or life sustaining applications, nor in products or systems where failure or malfunction may result in personal injury, death, or property or environmental damage.

General Sales Terms & Conditions apply.

For product information and a complete list of distributors, please go to our web site: www.x-relsemi.com



90, Avenue Leon Blum 38100 Grenoble — France

☎ : +33 456 580 580

✉ : support.XREL@easii-ic.com

EASii IC, X-REL Semiconductor, and the logo are trademarks of EASii IC in France and other countries.

Data subject to change. Copyright © 2002-2021 EASii IC. All rights reserved.